

# Serie 130 - UNI ISO 6150 B-15

## Caratteristiche Tecniche / Technical Characteristics

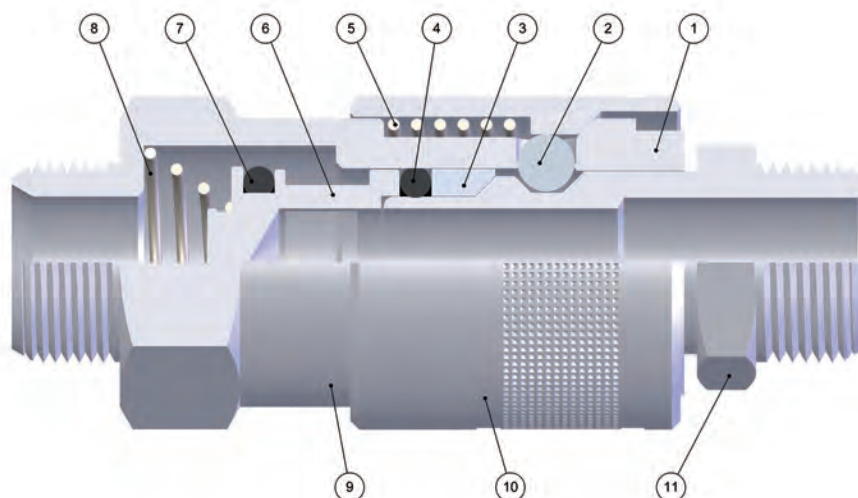

DN 9 mm

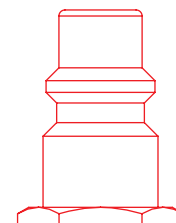
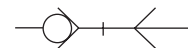

UNI ISO 6150  
B-15  
1:1

**FKM a richiesta**  
*FKM If required*

## Materiali e Componenti / Component Parts and Materials

- |  |  |
|--|--|
| 1 Corpo In Ottone Nichelato                | 1 Nickel-Plated Brass Body                 |
| 2 Sfera In Acciaio Aisi 420                | 2 Stainless Steel Aisi 420 Balls           |
| 3 Anello Guida Innesto In Ottone Nichelato | 3 Nickel-Plated Brass Guide Ring Coupling  |
| 4 Guarnizione O-Ring Innesto In Nbr        | 4 Nbr Plug O-Ring Seals                    |
| 5 Molla Ghiera In Acciaio Aisi 302         | 5 Stainless Steel Aisi 302 Ring Nut Spring |
| 6 Otturatore In Ottone Nichelato           | 6 Nickel-Plated Brass Shutter              |
| 7 Guarnizione O-Ring Otturatore In Nbr     | 7 Nbr Shutter O-Ring Seals                 |
| 8 Molla Otturatore In Acciaio Aisi 302     | 8 Stainless Steel Aisi 302 Shutter Spring  |
| 9 Attacco Terminale In Ottone Nichelato    | 9 Nickel-Plated Brass Coupling Back Part   |
| 10 Ghiera In Ottone Nichelato              | 10 Nickel-Plated Brass Sleeve              |
| 11 Innesto In Ottone Nichelato             | 11 Nickel-Plated Brass Plug Outline        |

## Pressioni / Pressures

Pressione d'esercizio: 0 - 16 bar  
Working pressure: 0 - 16 bar

## Portate / Flow Rate

Portate in NI/min Flow Rate in NI/min		
6 bar Δ 1	6 bar Δ 0,5	6 bar Δ 0 Scarico Libero Exhaust Free
2500	2050	3300

## Filettature / Threads

Gas cilindrica conforme ISO 228  
Parallel gas in conformity with ISO 228.

## Temperature / Temperatures

Temperatura minima / Minimum temperature: -20 °C  
Temperatura massima / Maximum temperature: +80 °C

NB: -10°C - +200°C CON O-RING IN FKM  
NB: -10°C - +200°C WITH FKM O-RING SEAL

## Tubi di collegamento / Connection Tubes

Tubi in materiale plastico, lineari o spiralati. Tubi in gomma.

Flexible tubes in plastic and rubber.

## Fluidi compatibili / Fluids

Aria compressa / Compressed air.

**Per altri fluidi, Consultare l'ufficio tecnico Aignep.**  
*For other fluids, consult the technical department Aignep.*

# 131

PRESA CON ATTACCO MASCHIO - MALE SOCKET

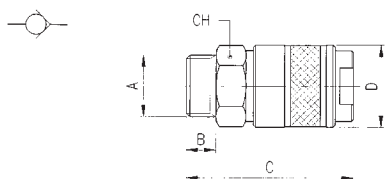

Codice Code	A	B	C	D	CH	Conf. Pack.
0013100001	3/8	9	56	28	24	10
0013100002	1/2	10	56	28	24	10

# 132

PRESA CON ATTACCO FEMMINA - FEMALE SOCKET

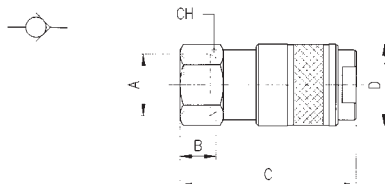

Codice Code	A	B	C	D	CH	Conf. Pack.
0013200001	3/8	11.5	56.5	28	24	10
0013200002	1/2	14	59	28	24	10

# 133

PRESA CON ATTACCO A CALZAMENTO CON MOLLA - COMPRESSION SOCKET WITH SPRING

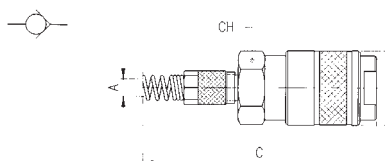

Codice Code	A	B	C	D	CH	Conf. Pack.
0013300001	10/8	-	155	28	24	10
0013300002	12/10	-	162.5	28	24	10

# 134

PRESA CON ATTACCO A CALZAMENTO - COMPRESSION SOCKET

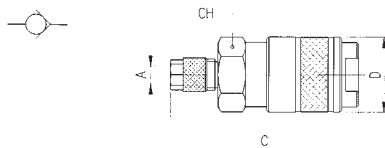

Codice Code	A	B	C	D	CH	Conf. Pack.
0013400001	10/8	-	61	28	24	10
0013400002	12/10	-	63	28	24	10

# 135

PRESA CON PORTAGOMMA A RESCA - SOCKET WITH REST FOR RUBBER HOSE

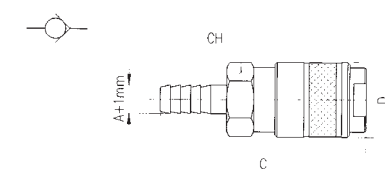

Codice Code	A	B	C	D	CH	Conf. Pack.
0013500001	8	-	66	28	24	10
0013500002	10	-	66	28	24	10
0013500003	12	-	66	28	24	10

# 231

INNESTO CON ATTACCO MASCHIO - MALE PLUG

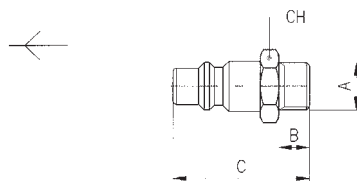

Codice Code	A	B	C	D	CH	Conf. Pack.
00231000104NB	3/8	9	40	-	19	25
00231000105NB	1/2	10	41.5	-	24	25

# 232

INNESTO CON ATTACCO FEMMINA - FEMALE PLUG

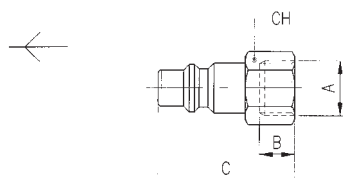

Codice Code	A	B	C	D	CH	Conf. Pack.
00232000104NB	3/8	11.5	39.5	-	20	25
00232000105NB	1/2	14	42	-	24	25

# 233

INNESTO CON ATTACCO A CALZAMENTO CON MOLLA - COMPRESSION PLUG WITH SPRING

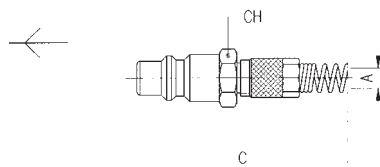

Codice Code	A	B	C	D	CH	Conf. Pack.
0023300001	10/8	-	140	-	16	10
0023300002	12/10	-	147	-	16	10

# 234

INNESTO CON ATTACCO A CALZAMENTO - COMPRESSION PLUG

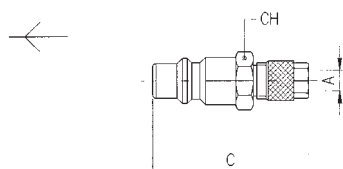

Codice Code	A	B	C	D	CH	Conf. Pack.
0023400001	10/8	-	46	-	16	25
0023400002	12/10	-	47.5	-	16	10

# 235

INNESTO CON PORTAGOMMA A RESCA - PLUG WITH REST FOR RUBBER HOSE

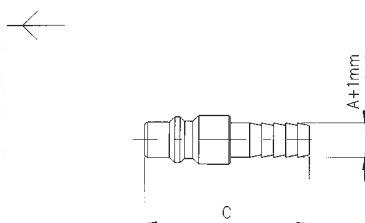

Codice Code	A	B	C	D	CH	Conf. Pack.
002350001X7NB	8	-	46	-	-	25
002350001X9NB	10	-	46	-	-	25
002350001Y1NB	12	-	48.5	-	-	25

# 237

INNESTO CON ATTACCO A BAIONETTA - BAYONET PLUG

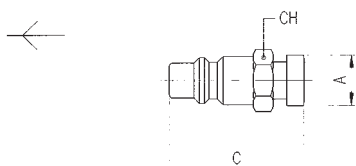

Codice Code	A	B	C	D	CH	Conf. Pack.
0023700001	15	-	39.5	-	16	25