

SN 25/SNI 30/SNI 39

Description

Product group	Rod seal
Design	NI asymmetrical u-ring with inner main sealing lip (30; 39), N symmetrical u-ring (25)
Profile no.	25/30/39
Specification	E suitable for one-sided pressure load
Model	ZL second seal lip (39)
Seal material	TPU 95 3401

Operational application limits

Pressure (MPa):	≤30 (25), ≤40 (30; 39)
Temperature (°C):	-40 to +100
Running speed (m/s):	≤0.5

Media

Hydraulic oils acc. to DIN 51524 Part 1 – 3, lubricating oils, mineral oil based lubricating greases, highly non-flammable hydraulic fluids HFA, HFB, HFC acc. to VDMA 24317

Function

The SNI 30 and SNI 39 u-rings are single-acting rod seals with an asymmetrical design. A second seal lip supports the sealing function of the SNI 39 u-ring. Due to the synergy of the geometry and material, this design is exceptionally well-suited for extreme loads. The SN 25 u-ring has a symmetrical design which allows its application as a piston seal and as a rod seal. Of the three designs the use of the SNI 30 is preferred for rod applications.

Installation

U-rings can be installed in both solid and split housings. Please note for a solid housing application a minimum width is necessary and suitable installation tool may be required (please see installation section on page 9).

Remarks

Seals made of TPU are very robust and are particularly well-suited for applications in mobile hydraulics and especially in the area of earth moving machines.

Order code

Please include our item numbers in your order. Should you require non-standard dimensions, materials or material combinations, please use the order code on page 12.

Any seal. Any time.

All the items in our standard programme (marked red) are standard stock items. For all other items, please check the availability at www.dichtomatik.de.

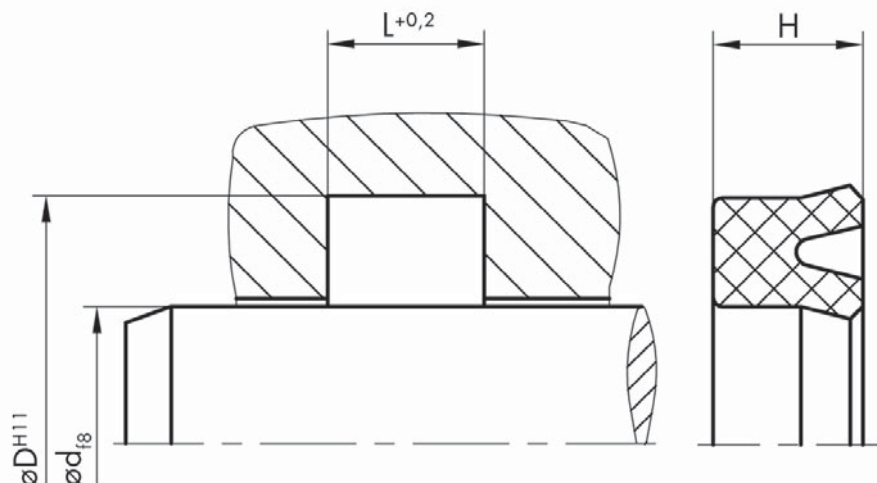

SN 25/SNI 30/SNI 39

Sizes

Item No.	Code	d	D	L	H
65467	SN 25 E	3	9	5	4.5
117817	SN 25 E	3	10	6	5
14434	SN 25 E	4	10	4.5	4
170974	SN 25 E	4	10	5	4
14645	SN 25 E	4	10	5.5	4.5
77514	SN 25 E	4	12	7	6
77515	SN 25 E	4	14	7	6
65468	SN 25 E	4.5	11	5.5	5
14646	SN 25 E	4.5	12.5	5	4.5
76236	SN 25 E	5	10	6	5
170983	SN 25 E	5	11	6	5
170985	SN 25 E	5	11	8	7
14435	SN 25 E	5	12	5.5	5
14436	SN 25 E	5	12	6.5	6
170989	SN 25 E	5	12	7	6.2
170991	SN 25 E	5	12.7	9	8.5
65810	SN 25 E	5	13	7	6
170993	SN 25 E	5	17	10	9
16191	SNI 30 E	6	10	3.5	3
123223	SN 25 E	6	10	3.5	3
69668	SN 25 E	6	11	8	7
170995	SN 25 E	6	12	4.5	3.5
14647	SN 25 E	6	12	5	4
66172	SN 25 E	6	12	5	4.5
37957	SNI 30 E	6	12	5.2	4.5
171058	SNI 30 E	6	12	5.8	5.3
66173	SN 25 E	6	12	6	5
14648	SN 25 E	6	12	6.5	5.5
14649	SN 25 E	6	12	7	6
171002	SN 25 E	6	12	8	7
171004	SN 25 E	6	12.7	6.5	6
7372	SNI 39 E ZL	6	13	5.5	5
122341	SNI 30 E	6	13	5.6	5
67783	SN 25 E	6	13	9	8
16008	SNI 30 E	6	14	6.3	5.7
80267	SNI 39 E ZL	6	14	6.3	5.7
80266	SNI 39 E ZL	6	14	6.5	5.5
77410	SN 25 E	6	14	7	6
66203	SN 25 E	6	15	5	4
171009	SN 25 E	6	15	6	5
14437	SN 25 E	6	15	9	8
171012	SN 25 E	6	16	7	6
171014	SN 25 E	7	14	4.2	3.2
168732	SN 25 E	7	14	4.2	3.5
67784	SN 25 E	7	14	5	4
171016	SN 25 E	7	15	6	5
14650	SN 25 E	7	15	8	7
127340	SNI 30 E	8	14	4	3.5
14726	SN 25 E	8	14	5	4
157093	SNI 30 E	8	14	6	5
14651	SN 25 E	8	14	7	6
14652	SN 25 E	8	15	6.3	5.7
66181	SN 25 E	8	15	7	6
77537	SN 25 E	8	15	8	7
14439	SN 25 E	8	15	9	8

SN 25/SNI 30/SNI 39

Item No. Code d D L H

Sizes

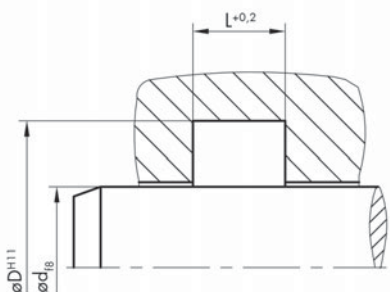

14653	SN 25 E	8	16	6.3	5.7
16010	SNI 30 E	8	16	6.3	5.7
125056	SNI 39 E ZL	8	16	6.3	5.7
80268	SNI 39 E ZL	8	16	6.5	5.5
14440	SN 25 E	8	16	7	6
79389	SN 25 E	8	16	9	8
16194	SNI 30 E	8	16	9	8
80270	SNI 39 E ZL	8	16	9	8
36767	SN 25 E	8	18	7	6
171030	SN 25 E	8	18	9	8
171059	SNI 30 E	8	18	9	8
80269	SNI 39 E ZL	8	18	9	8
14654	SN 25 E	8	18	10	9
14655	SN 25 E	8	22	9	8
14441	SN 25 E	9	15	9	8
168761	SN 25 E	9	19	7	6.5
14757	SN 25 E	9	19	7	6
159096	SNI 39 E ZL	9.52	19.05	8.72	7.93
62959	SN 25 E	10	14	3.5	3
67785	SN 25 E	10	15	5	4
14442	SN 25 E	10	16	5	4
16192	SNI 30 E	10	16	5.2	4.5
46908	SNI 39 E ZL	10	16	5.3	4.5
168742	SN 25 E	10	16	6	5
14443	SN 25 E	10	16	6.5	6
14444	SN 25 E	10	18	6	5.5
14656	SN 25 E	10	18	6	5
16011	SNI 30 E	10	18	6.3	5.7
125059	SNI 39 E ZL	10	18	6.3	5.7
80272	SNI 39 E ZL	10	18	6.5	5.5
14445	SN 25 E	10	18	7	6
14657	SN 25 E	10	18	9	8
46909	SNI 39 E ZL	10	20	5	4.5
20918	SN 25 E	10	20	6	5
67786	SN 25 E	10	20	7	6
16012	SNI 30 E	10	20	8	7.2
80271	SNI 39 E ZL	10	20	8	7
14446	SN 25 E	10	20	9	8
171060	SNI 30 E	10	20	9	8
80273	SNI 39 E ZL	10	20	9	8
14658	SN 25 E	10	22	7	6
14447	SN 25 E	10	22	9	8
168827	SN 25 E	10	25	11	10
14448	SN 25 E	10	32	11	10
168745	SN 25 E	11	17	5	4
168789	SN 25 E	11	20.5	7	6.5
168787	SN 25 E	11	20.5	7	6
64615	SN 25 E	12	18	5	4
168754	SN 25 E	12	18	5.5	5
14449	SN 25 E	12	18	6	5
14450	SN 25 E	12	18	7	6
66207	SN 25 E	12	20	6	5
16013	SNI 30 E	12	20	6.3	5.7
125060	SNI 39 E ZL	12	20	6.3	5.7
132998	SN 25 E	12	20	6.3	5.5

SN 25/SNI 30/SNI 39

Sizes

Item No.	Code	d	D	L	H
125061	SNI 39 E ZL	12	20	6.5	5.5
76119	SN 25 E	12	20	8	7
14451	SN 25 E	12	20	9	8
80275	SNI 39 E ZL	12	20	9	8
14660	SN 25 E	12	22	6	5
66209	SN 25 E	12	22	7	6
14661	SN 25 E	12	22	8	7
16014	SNI 30 E	12	22	8	7.2
125062	SNI 39 E ZL	12	22	8	7.3
14452	SN 25 E	12	22	9	8
15920	SNI 30 E	12	22	9	8
89160	SNI 39 E ZL	12	22	9	8
67796	SN 25 E	12	24	7	6
14662	SN 25 E	12	24	9	8
14663	SN 25 E	12	24	10	9
168814	SN 25 E	12	24	11	10
14664	SN 25 E	12	25	9	8
14453	SN 25 E	12	25	11	10
80217	SN 25 E	12	27	8.5	7.5
168770	SN 25 E	12.7	19.05	5.56	3.96
159097	SNI 39 E ZL	12.7	19.05	6.35	4.76
130049	SN 25 E	13.5	20	5	4
67794	SN 25 E	14	20	5	4
14735	SN 25 E	14	20	5.3	4.8
66219	SN 25 E	14	20	6	5
168785	SN 25 E	14	20	7	6
66754	SNI 30 E	14	21	5.6	5
124729	SN 25 E	14	22	5	4.5
149569	SN 25 E	14	22	4.5	4
66221	SN 25 E	14	22	6	5
16015	SNI 30 E	14	22	6.3	5.7
125063	SNI 39 E ZL	14	22	6.3	5.7
80277	SNI 39 E ZL	14	22	6.5	5.5
14665	SN 25 E	14	22	7	6
14666	SN 25 E	14	22	9	8
14736	SN 25 E	14	22	12	11
123278	SN 25 E	14	24	7	6
16016	SNI 30 E	14	24	8	7.2
120825	SNI 39 E ZL	14	24	8	7.3
14455	SN 25 E	14	24	9	8
15913	SNI 30 E	14	24	9	8
80274	SNI 39 E ZL	14	24	9	8
67231	SNI 39 E ZL	14	24	8.2	7.2
67798	SN 25 E	14	26	9	8
168868	SN 25 E	14	28	11	10
159098	SNI 39 E ZL	14.28	20.63	6.35	4.76
14727	SN 25 E	15	22	5	4
156397	SNI 39 E ZL	15	22	6	5
84088	SN 25 E	15	22	8	7
16017	SNI 30 E	15	23	6.3	5.7
80218	SN 25 E	15	25	6	5
66227	SN 25 E	15	25	7	6
14456	SN 25 E	15	25	9	8
15980	SNI 30 E	15	25	9	8
80276	SNI 39 E ZL	15	25	9	8

SN 25/SNI 30/SNI 39

Item No. Code d D L H

Sizes

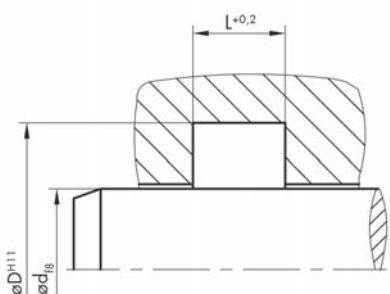

14457	SN 25 E	15	25	11	10
170883	SNI 39 E ZL	15	26	8	7.5
14667	SN 25 E	15	27	7	6
89354	SNI 30 E	15	27	13	12
168870	SN 25 E	15	28	9	8
14458	SN 25 E	15	28	11	10
168888	SN 25 E	15	30	7	6
67790	SN 25 E	15	30	9	8
69525	SN 25 E	15	30	11	10
68107	SNI 39 E ZL	15.4	25.5	7.4	6.5
72766	SNI 30 E	15.87	22.22	4.77	3.17
159099	SNI 39 E ZL	15.87	22.22	6.35	4.76
159100	SNI 39 E ZL	15.87	25.4	7.93	7.14
171061	SNI 30 E	16	20.6	3.6	3.3
14459	SN 25 E	16	22	4.5	4
127498	SNI 30 E	16	22	4.8	3.8
14668	SN 25 E	16	22	5.5	5
15914	SNI 30 E	16	22	5.5	5
171062	SNI 30 E	16	22	6	5.5
16200	SNI 30 E	16	22	11	10
66233	SN 25 E	16	24	6	5
16018	SNI 30 E	16	24	6.3	5.7
125064	SNI 39 E ZL	16	24	6.3	5.8
80280	SNI 39 E ZL	16	24	6.5	5.5
171063	SNI 30 E	16	24	7	6.2
14643	SN 25 E	16	24	10	9
62192	SN 25 E	16	25	9	8
14669	SN 25 E	16	26	6	5
69981	SNI 30 E	16	26	6	5
168848	SN 25 E	16	26	7	6
16020	SNI 30 E	16	26	8	7.2
80283	SNI 39 E ZL	16	26	8	7.3
80279	SNI 39 E ZL	16	26	8	7
14461	SN 25 E	16	26	9	8
15915	SNI 30 E	16	26	9	8
80281	SNI 39 E ZL	16	26	9	8
65479	SNI 30 E	16	26	10	9
14462	SN 25 E	16	26	11	10
14640	SN 25 E	16	28	7	6
130409	SNI 39 E ZL	16	28	9	8
118528	SN 25 E	16	28	11	10
14737	SN 25 E	16	32	9	8
69667	SN 25 E	16.5	24	11	10
126045	SNI 39 E ZL	17	23	5	4
149570	SN 25 E	17	25	4.5	4
77516	SN 25 E	17	25	9	8
14463	SN 25 E	17	25	11	10
168908	SN 25 E	17	32	11	10
93295	SN 25 E	17	35	11	10
159101	SNI 39 E ZL	17.46	23.81	6.35	4.76
171064	SNI 30 E	18	24	5.2	4.7
156740	SNI 30 E	18	24	6	5
149517	SN 25 E	18	24	9	8
14670	SN 25 E	18	25	5.5	5
89161	SNI 39 E ZL	18	25	5.5	5

SN 25/SNI 30/SNI 39

Sizes

Item No.	Code	d	D	L	H
73769	SNI 30 E	18	25	6	5
80568	SN 25 E	18	25	7	6
149571	SN 25 E	18	26	4.5	4
66244	SN 25 E	18	26	6	5
16022	SNI 30 E	18	26	6.3	5.7
80278	SNI 39 E ZL	18	26	6.3	5.5
170884	SNI 39 E ZL	18	26	7	6.5
68108	SNI 39 E ZL	18	26	7	6.3
14671	SN 25 E	18	26	7.5	6.5
14464	SN 25 E	18	26	9	8
16176	SNI 30 E	18	26	9	8
170885	SNI 39 E ZL	18	26	9	8.5
14672	SN 25 E	18	26	9.5	8.5
16023	SNI 30 E	18	28	8	7.2
80284	SNI 39 E ZL	18	28	8	7.3
14465	SN 25 E	18	28	9	8
15916	SNI 30 E	18	28	9	8
80282	SNI 39 E ZL	18	28	9	8
14673	SN 25 E	18	30	9	8
168894	SN 25 E	18	30	11	10
168910	SN 25 E	18	32	8	7
67800	SN 25 E	18	34	9	8
84316	SN 25 E	18	35	9	8
14641	SN 25 E	19	25	7	6
70887	SN 25 E	19	27	6	5
159104	SNI 39 E ZL	19.05	25.4	7.14	6.35
21900	SN 25 E	19.05	25.4	7.14	6.35
159103	SNI 39 E ZL	19.05	25.4	6.35	4.76
159105	SNI 39 E ZL	19.05	28.57	8.72	7.93
170886	SNI 39 E ZL	19.5	27.5	9	8.5
74875	SNI 30 E	20	26	4	3.5
67787	SN 25 E	20	26	5	4
89162	SNI 39 E ZL	20	26	5.3	4.8
16024	SNI 30 E	20	26	5.6	5
16199	SNI 30 E	20	27	7	6
14468	SN 25 E	20	27	7	6
14469	SN 25 E	20	28	5	4
66251	SN 25 E	20	28	6	5
16025	SNI 30 E	20	28	6.3	5.7
119003	SNI 39 E ZL	20	28	6.5	5.5
16026	SNI 30 E	20	28	7	6.2
35920	SN 25 E	20	28	7	6
171066	SNI 30 E	20	28	8	7.2
14470	SN 25 E	20	28	9	8
168886	SN 25 E	20	29	5.5	5
66254	SN 25 E	20	30	7	6
124677	SNI 39 E ZL	20	30	7	6
16028	SNI 30 E	20	30	8	7.2
80287	SNI 39 E ZL	20	30	8	7
14471	SN 25 E	20	30	9	8
15917	SNI 30 E	20	30	9	8
82079	SNI 39 E ZL	20	30	9	8
14416	SN 25 E	20	30	11	10
15918	SNI 30 E	20	30	11	10
80288	SNI 39 E ZL	20	30	11	10

SN 25/SNI 30/SNI 39

Item No. Code d D L H

Sizes

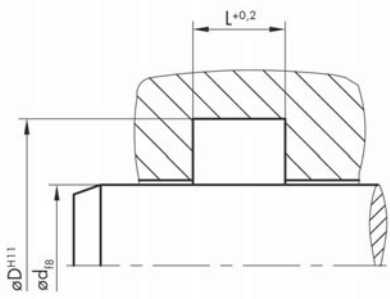

168912	SN 25 E	20	32	6	5
67793	SN 25 E	20	32	7	6
14675	SN 25 E	20	32	8.5	7.5
171067	SNI 30 E	20	32	8.5	7.5
14472	SN 25 E	20	32	9	8
14969	SN 25 E	20	33	9	8
126127	SN 25 E	20	35	9	8
67802	SN 25 E	20	35	11	10
171068	SNI 30 E	20	35	11	10
80289	SNI 39 E ZL	20	35	11	10
14473	SN 25 E	20	35	13	12
168961	SN 25 E	20	36	9	8
150010	SN 25 E	20	36	11	10
168991	SN 25 E	20	39	11	10.5
14676	SN 25 E	20	40	11	10
14475	SN 25 E	20	40	13	12
73164	SN 25 E	20	43	13	12
159107	SNI 39 E ZL	20.63	26.98	7.14	6.35
159106	SNI 39 E ZL	20.63	26.98	6.35	4.76
14476	SN 25 E	21	37	13	12
14728	SN 25 E	22	28	5	4
14677	SN 25 E	22	28	9	8
45725	SN 25 E	22	30	5	4
168900	SN 25 E	22	30	6	5
16029	SNI 30 E	22	30	6.3	5.7
152165	SNI 39 E ZL	22	30	6.3	5.7
14678	SN 25 E	22	30	7	6
6294	SNI 39 E ZL	22	30	7	6
14477	SN 25 E	22	30	7.5	7
16197	SNI 30 E	22	30	8	7
124678	SNI 39 E ZL	22	30	8	7
117377	SNI 30 E	22	30	9	8
14478	SN 25 E	22	30	11	10
56369	SN 25 E	22	32	6	5
170887	SNI 39 E ZL	22	32	7	6
117410	SN 25 E	22	32	8	7
16030	SNI 30 E	22	32	8	7.2
125065	SNI 39 E ZL	22	32	8	7.3
14479	SN 25 E	22	32	9	8
15919	SNI 30 E	22	32	9	8
80261	SNI 39 E ZL	22	32	9	8
171069	SNI 30 E	22	32	10	9
14480	SN 25 E	22	32	11	10
171070	SNI 30 E	22	32	11	10
67801	SN 25 E	22	34	7	6
162251	SN 25 E	22	34	8	7
67803	SN 25 E	22	35	6	5
14481	SN 25 E	22	35	11	10
125066	SNI 39 E ZL	22	35	11	10
72682	SN 25 E	22	35.5	11	10
67811	SN 25 E	22	40	11	10
159109	SNI 39 E ZL	22.22	28.57	7.14	6.35
159108	SNI 39 E ZL	22.22	28.57	6.35	4.76
125067	SNI 39 E ZL	23	35	11	10
89360	SNI 30 E	23	40	19	18

SN 25/SNI 30/SNI 39

Sizes

Item No.	Code	d	D	L	H
168922	SN 25 E	24	32	5	4
14679	SN 25 E	24	32	7.5	7
168925	SN 25 E	24	32	8	7.5
171071	SNI 30 E	24	34	8	7.2
171072	SNI 30 E	24	34	9.5	8.5
14482	SN 25 E	24	40	9	8
78775	SN 25 E	25	32	5	4
83381	SNI 30 E	25	32	7	6
89163	SNI 39 E ZL	25	32	11	10
29538	SN 25 E	25	33	5	4
66276	SN 25 E	25	33	6	5
16033	SNI 30 E	25	33	6.3	5.7
170890	SNI 39 E ZL	25	33	6.3	4.8
80920	SNI 39 E ZL	25	33	6.5	5.5
16177	SNI 30 E	25	33	7	6.2
68112	SNI 39 E ZL	25	33	7.3	6.5
22679	SNI 30 E	25	33	7.3	6.5
14483	SN 25 E	25	33	7.5	7
170889	SNI 39 E ZL	25	33	7.5	7
16034	SNI 30 E	25	33	8	7.2
170888	SNI 39 E ZL	25	33	8	7.3
79724	SN 25 E	25	33	9	8
80843	SNI 30 E	25	33	9	8
16035	SNI 30 E	25	33	11	10
80380	SNI 39 E ZL	25	33	11	10
127178	SN 25 E	25	34	8	7
14644	SN 25 E	25	35	5.5	5
27567	SN 25 E	25	35	7	6
117411	SN 25 E	25	35	8	7
16036	SNI 30 E	25	35	8	7.2
125068	SNI 39 E ZL	25	35	8	7.3
80290	SNI 39 E ZL	25	35	8	7
14484	SN 25 E	25	35	9	8
15922	SNI 30 E	25	35	9	8
89164	SNI 39 E ZL	25	35	9	8
14485	SN 25 E	25	35	11	10
15923	SNI 30 E	25	35	11	10
80291	SNI 39 E ZL	25	35	11	10
168972	SN 25 E	25	37	8	7
171073	SNI 30 E	25	38	10	9
88170	SN 25 E	25	38	10.5	9.5
14486	SN 25 E	25	38	11	10
14487	SN 25 E	25	40	11	10
15924	SNI 30 E	25	40	11	10
80296	SNI 39 E ZL	25	40	11	10
78225	SN 25 E	25	42	8	7
169048	SN 25 E	25	45	11	10
80315	SNI 39 E ZL	25	45	13	12
66811	SN 25 E	25.4	31.75	6.35	4.76
159111	SNI 39 E ZL	25.4	31.75	7.14	6.35
159110	SNI 39 E ZL	25.4	31.75	6.35	4.76
159112	SNI 39 E ZL	25.4	34.92	7.14	6.35
46579	SN 25 E	25.4	34.92	8.72	7.93
159113	SNI 39 E ZL	25.4	34.92	8.72	7.93
66815	SN 25 E	25.4	38.1	7.14	6.35

SN 25/SNI 30/SNI 39

Item No.	Code	d	D	L	H
159114	SNI 39 E ZL	25.4	38.1	10.31	9.52
77386	SN 25 E	26	38	9	8
14489	SN 25 E	26	47	13	12
159115	SNI 39 E ZL	26.98	33.34	6.35	4.76
110310	SN 25 E	27	34	8	7
117413	SN 25 E	27	35	4.5	4
14490	SN 25 E	27	36	7	6
168979	SN 25 E	27	38	7	6
14680	SN 25 E	28	35	5.5	5
66291	SN 25 E	28	35.5	6	5
29540	SN 25 E	28	36	5	4
14491	SN 25 E	28	36	6	5
16037	SNI 30 E	28	36	6.3	5.7
168968	SN 25 E	28	36	7	6
14681	SN 25 E	28	36	7.5	6.5
125069	SNI 39 E ZL	28	36	8	7.3
80295	SNI 39 E ZL	28	36	8	7
16038	SNI 30 E	28	38	8	7.2
125070	SNI 39 E ZL	28	38	8	7.3
14492	SN 25 E	28	38	9	8
15925	SNI 30 E	28	38	9	8
14682	SN 25 E	28	38	11	10
171074	SNI 30 E	28	38	11	10
80293	SNI 39 E ZL	28	38	11	10
73204	SN 25 E	28	39	8.3	7.25
130050	SN 25 E	28	40	7	6
67812	SN 25 E	28	40	9	8
171075	SNI 30 E	28	40	9.5	8.5
14493	SN 25 E	28	40	11	10
80848	SNI 30 E	28	40	11	10
169037	SN 25 E	28	43	11	10
16040	SNI 30 E	28	43	12.5	11.5
125072	SNI 39 E ZL	28	43	12.5	11.5
14494	SN 25 E	28	44	9	8
69341	SN 25 E	28	46	11	10
89361	SNI 30 E	28	48	19	18
159117	SNI 39 E ZL	28.57	34.92	7.14	6.35
159116	SNI 39 E ZL	28.57	34.92	6.35	4.76
159118	SNI 39 E ZL	28.57	38.1	8.72	7.93
46850	SN 25 E	28.57	38.1	8.72	7.93
159119	SNI 39 E ZL	28.57	41.27	7.14	6.35
171076	SNI 30 E	29	35	6.3	4.8
118407	SN 25 E	30	37	6.8	5.8
14495	SN 25 E	30	37	7	6
168983	SN 25 E	30	38	5	4
67810	SN 25 E	30	38	6	5
16041	SNI 30 E	30	38	6.3	5.7
170891	SNI 39 E ZL	30	38	6.3	4.8
14683	SN 25 E	30	38	6.5	6
14496	SN 25 E	30	38	8	7
16179	SNI 30 E	30	38	9	8
14684	SN 25 E	30	40	5.5	5
171077	SNI 30 E	30	40	6.3	5.7
66298	SN 25 E	30	40	6.5	5.5
66299	SN 25 E	30	40	7	6

Sizes

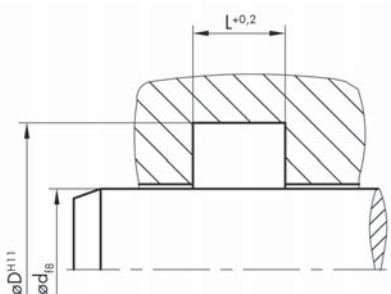

SN 25/SNI 30/SNI 39

Sizes

Item No.	Code	d	D	L	H
67817	SN 25 E	30	40	7.5	6.5
170892	SNI 39 E ZL	30	40	7.5	7
79728	SN 25 E	30	40	8	7
80230	SNI 30 E	30	40	8	7
68114	SNI 39 E ZL	30	40	8	7.3
16043	SNI 30 E	30	40	8.2	7.2
7162	SN 25 E	30	40	9	8
171078	SNI 30 E	30	40	10.5	9.5
14413	SN 25 E	30	40	11	10
15927	SNI 30 E	30	40	11	10
80297	SNI 39 E ZL	30	40	11	10
14685	SN 25 E	30	42	10	9
14423	SN 25 E	30	42	11	10
171079	SNI 30 E	30	43	10	9
171080	SNI 30 E	30	45	9	8
66303	SN 25 E	30	45	10	9
14497	SN 25 E	30	45	11	10
15910	SNI 30 E	30	45	11	10
80298	SNI 39 E ZL	30	45	11	10
25960	SN 25 E	30	46	11	10
14498	SN 25 E	30	50	11	10
14499	SN 25 E	30	50	13	12
125073	SNI 39 E ZL	30	50	13	12
80146	SNI 30 E	30	50	16	15
159120	SNI 39 E ZL	30.16	39.68	7.14	6.35
150523	SNI 30 E	30.95	45.24	11.5	10.31
159121	SNI 39 E ZL	31.75	38.1	7.14	6.35
159123	SNI 39 E ZL	31.75	41.27	7.14	6.35
159124	SNI 39 E ZL	31.75	41.27	8.72	7.93
159122	SNI 39 E ZL	31.75	41.27	6.35	4.76
159125	SNI 39 E ZL	31.75	44.45	7.14	6.35
36718	SN 25 E	31.75	44.45	10.31	9.52
159126	SNI 39 E ZL	31.75	44.45	10.31	9.52
71679	SN 25 E	32	40	5	4
117417	SN 25 E	32	40	6	5
16047	SNI 30 E	32	40	6.3	5.7
14686	SN 25 E	32	40	6.5	5.5
66311	SN 25 E	32	40	7	6
68115	SNI 39 E ZL	32	40	7.5	6.7
170893	SNI 39 E ZL	32	40	7.7	7.2
14500	SN 25 E	32	40	8	7
14501	SN 25 E	32	40	9	8
16048	SNI 30 E	32	40	9	8
80299	SNI 39 E ZL	32	40	9	8
79729	SN 25 E	32	40	11	10
68116	SNI 39 E ZL	32	41.5	8.9	7.9
117418	SN 25 E	32	42	7	6
16049	SNI 30 E	32	42	8	7.2
90530	SNI 30 E	32	42	8	7
125074	SNI 39 E ZL	32	42	8	7.3
80849	SNI 30 E	32	42	9	8
14502	SN 25 E	32	42	11	10
15929	SNI 30 E	32	42	11	10
80303	SNI 39 E ZL	32	42	11	10
171081	SNI 30 E	32	42.53	9	8.5

SN 25/SNI 30/SNI 39

Item No. Code d D L H

Sizes

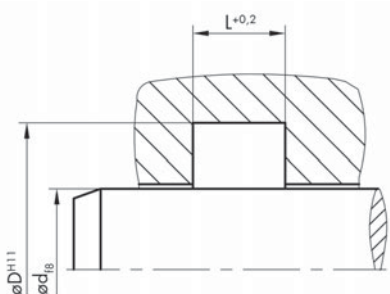

171082	SNI 30 E	32	45	10.5	9.5
14503	SN 25 E	32	45	11	10
74321	SNI 30 E	32	45	11	10
80304	SNI 39 E ZL	32	45	11	10
36681	SN 25 E	32	47	11	10
15930	SNI 30 E	32	47	11	10
125075	SNI 39 E ZL	32	47	11	10
125076	SNI 39 E ZL	32	47	12.5	11.5
78226	SN 25 E	32	48	8	7
67815	SN 25 E	32	50	11	10
24850	SN 25 E	32	50	13	12
66315	SN 25 E	32	52	11	10
35982	SN 25 E	33	43	11	10
171083	SNI 30 E	33	43	11	10
169053	SN 25 E	34	45	8	7
14688	SN 25 E	34	45	10	9
169084	SN 25 E	34	50	15	14
159127	SNI 39 E ZL	34.92	41.27	7.14	6.35
159129	SNI 39 E ZL	34.92	44.45	8.72	7.93
159128	SNI 39 E ZL	34.92	44.45	6.35	4.76
159130	SNI 39 E ZL	34.92	47.62	10.31	9.52
16052	SNI 30 E	35	43	6.3	5.7
79732	SN 25 E	35	43	7	6
14505	SN 25 E	35	43	8	7
170894	SNI 39 E ZL	35	43	8	7.2
16180	SNI 30 E	35	43	9	8
79733	SN 25 E	35	43	9	8
66322	SN 25 E	35	45	7	6
171084	SNI 30 E	35	45	7	6
16053	SNI 30 E	35	45	8	7.2
148964	SNI 30 E	35	45	8	7
125077	SNI 39 E ZL	35	45	8	7
14639	SN 25 E	35	45	9	8
89169	SNI 39 E ZL	35	45	9	8
117282	SNI 30 E	35	45	9	8
14506	SN 25 E	35	45	11	10
15979	SNI 30 E	35	45	11	10
80305	SNI 39 E ZL	35	45	11	10
171085	SNI 30 E	35	45	13.5	13
171086	SNI 30 E	35	46	9	8
171087	SNI 30 E	35	46	10	9
171088	SNI 30 E	35	47	9	8.5
67813	SN 25 E	35	47	11	10
14507	SN 25 E	35	48	11	10
24718	SN 25 E	35	50	8	7
67816	SN 25 E	35	50	9	8
14508	SN 25 E	35	50	11	10
15981	SNI 30 E	35	50	11	10
89170	SNI 39 E ZL	35	50	11	10
14741	SN 25 E	35	55	11	10
14509	SN 25 E	35	55	13	12
171089	SNI 30 E	35	55	13	12
171034	SN 25 E	35.5	43.5	9	8
66330	SN 25 E	35.5	45	7	6
62958	SN 25 E	36	44	5	4

SN 25/SNI 30/SNI 39

Sizes

Item No.	Code	d	D	L	H
5016	SNI 30 E	36	44	6.3	5.7
89985	SN 25 E	36	44	6.5	5.7
68118	SNI 39 E ZL	36	44	7	6.3
80752	SNI 30 E	36	44	9	8
66331	SN 25 E	36	45	11	10
14689	SN 25 E	36	46	8	7
16058	SNI 30 E	36	46	8	7.2
125078	SNI 39 E ZL	36	46	8	7.3
76441	SNI 39 E ZL	36	46	8	7
80308	SNI 39 E ZL	36	46	8.5	7.5
36438	SN 25 E	36	46	11	10
15931	SNI 30 E	36	46	11	10
81952	SNI 39 E ZL	36	46	11	10
171098	SNI 30 E	36	48	8	7.5
16059	SNI 30 E	36	48	9	8
169090	SN 25 E	36	50	9	8
7553	SN 25 E	36	50	11	10
117395	SN 25 E	36	51	11	10
171099	SNI 30 E	36	51	11	10
80309	SNI 39 E ZL	36	51	11	10
16060	SNI 30 E	36	51	12.5	11.5
131094	SNI 30 E	36	52	12.5	11.5
130051	SN 25 E	36	56	11	10
80306	SNI 39 E ZL	36	56	13	12
14690	SN 25 E	36	70	11	10
159131	SNI 39 E ZL	36.51	46.04	8.72	7.93
171100	SNI 30 E	37	45	6.3	5.7
80310	SNI 39 E ZL	37	47	9	8
64925	SNI 30 E	37	47	11	10
80307	SNI 39 E ZL	37	47	11	10
171101	SNI 30 E	38	44.5	5.3	4.8
14691	SN 25 E	38	45	5.5	5
171102	SNI 30 E	38	45	5.5	5
14510	SN 25 E	38	45	7	6
171103	SNI 30 E	38	45	7	6.2
67820	SN 25 E	38	45	9	8
14692	SN 25 E	38	46	7.5	6.5
169094	SN 25 E	38	50	7	6
14693	SN 25 E	38	50	10	9
14512	SN 25 E	38	50	11	10
14513	SN 25 E	38	55	11	10
80311	SNI 39 E ZL	38	55	11	10
14742	SN 25 E	38	58	11	10
159132	SNI 39 E ZL	38.1	44.45	7.14	6.35
159134	SNI 39 E ZL	38.1	47.62	7.14	6.35
162623	SN 25 E	38.1	47.62	8.72	7.93
159135	SNI 39 E ZL	38.1	47.62	8.72	7.93
159136	SNI 39 E ZL	38.1	47.62	10.31	9.52
159133	SNI 39 E ZL	38.1	47.62	6.35	4.76
159137	SNI 39 E ZL	38.1	50.8	7.14	6.35
159138	SNI 39 E ZL	38.1	50.8	10.31	9.52
36407	SN 25 E	38.1	50.8	10.31	9.52
159139	SNI 39 E ZL	38.1	53.97	10.31	9.52
169991	SN 25 E	39	47	7	6
66342	SN 25 E	40	48	6	5

Sizes

16064	SNI 30 E	40	48	6.3	5.7
125079	SNI 39 E ZL	40	48	6.3	5.7
66343	SN 25 E	40	48	9	8
80235	SNI 30 E	40	48	9	8
157464	SNI 39 E ZL	40	48	9	8
22665	SN 25 E	40	48	12	11
68119	SNI 39 E ZL	40	49.5	10.5	9.5
171104	SNI 30 E	40	49.52	10.5	10
67822	SN 25 E	40	50	6	5
66345	SN 25 E	40	50	7	6
14694	SN 25 E	40	50	7.5	6.5
66346	SN 25 E	40	50	8	7
16066	SNI 30 E	40	50	8	7.2
68120	SNI 39 E ZL	40	50	8	7.3
169101	SN 25 E	40	50	8	7.2
66748	SN 25 E	40	50	9	8
117385	SNI 30 E	40	50	9	8
133008	SN 25 E	40	50	10	9
171105	SNI 30 E	40	50	10	9
14514	SN 25 E	40	50	11	10
15933	SNI 30 E	40	50	11	10
78880	SNI 39 E ZL	40	50	11	10
171106	SNI 30 E	40	50	13.5	12.5
106894	SNI 39 E ZL	40	50	10.31	9.37
16068	SNI 30 E	40	52	9	8
43071	SNI 30 E	40	55	8	7.2
14415	SN 25 E	40	55	11	10
15934	SNI 30 E	40	55	11	10
68121	SNI 39 E ZL	40	55	11	10
16069	SNI 30 E	40	55	12.5	11.5
80312	SNI 39 E ZL	40	55	12.5	11.5
169135	SN 25 E	40	56	9	8
14743	SN 25 E	40	56	11	10
14516	SN 25 E	40	60	11	10
14517	SN 25 E	40	60	13	12
171107	SNI 30 E	40	60	13	12
80313	SNI 39 E ZL	40	60	13	12
14695	SN 25 E	40	60	14	13
14518	SN 25 E	40	60	19	18
169186	SN 25 E	40	65	11	10
14519	SN 25 E	40	65	13	12
76182	SN 25 E	40	65	20	18.7
169217	SN 25 E	40	70	16	15
169251	SN 25 E	40	75	11	10.5
159140	SNI 39 E ZL	41.27	47.62	7.14	6.35
159142	SNI 39 E ZL	41.27	50.8	8.72	7.93
159143	SNI 39 E ZL	41.27	50.8	10.31	9.52
159141	SNI 39 E ZL	41.27	50.8	7.93	7.14
159144	SNI 39 E ZL	41.27	53.97	10.31	9.52
161081	SNI 39 E ZL	42	48	7	6
44785	SNI 30 E	42	50	7.5	6.5
14520	SN 25 E	42	50	9	8
118318	SNI 30 E	42	50	9	8
36691	SNI 39 E ZL	42	50	12.5	11.5
171035	SN 25 E	42	52	7	6

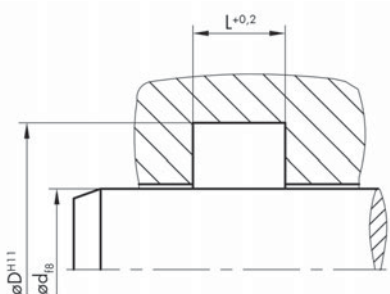

SN 25/SNI 30/SNI 39

Sizes

Item No.	Code	d	D	L	H
169116	SN 25 E	42	52	10	9
14521	SN 25 E	42	52	11	10
89171	SNI 39 E ZL	42	52	11	10
68123	SNI 39 E ZL	42	53	10	9
171108	SNI 30 E	42	62	11	10.5
14729	SN 25 E	42	62	13	12
171109	SNI 30 E	42	62	13	12.5
71716	SN 25 E	42	72	11	10
159145	SNI 39 E ZL	44.45	50.8	7.14	6.35
159146	SNI 39 E ZL	44.45	53.97	7.14	6.35
159148	SNI 39 E ZL	44.45	53.97	8.72	7.93
159149	SNI 39 E ZL	44.45	53.97	10.31	9.52
159150	SNI 39 E ZL	44.45	57.15	7.14	6.35
46585	SN 25 E	44.45	57.15	10.31	9.52
159151	SNI 39 E ZL	44.45	57.15	10.31	9.52
159152	SNI 39 E ZL	44.45	57.15	14.3	12.7
16070	SNI 30 E	45	53	6.3	5.7
125081	SNI 39 E ZL	45	53	6.3	5.6
89986	SN 25 E	45	53	6.5	5.7
67826	SN 25 E	45	53	9	8
73773	SNI 30 E	45	53	9	8
16071	SNI 30 E	45	53	11	10
68125	SNI 39 E ZL	45	53	12.5	11.5
20958	SN 25 E	45	53	13	12
16072	SNI 30 E	45	53	13	12
29542	SN 25 E	45	55	6	5
125030	SNI 30 E	45	55	6.3	5.7
148582	SNI 30 E	45	55	6.5	5.8
66362	SN 25 E	45	55	7	6
14697	SN 25 E	45	55	7.5	6.5
16073	SNI 30 E	45	55	8	7.2
125082	SNI 39 E ZL	45	55	8	7.3
80317	SNI 39 E ZL	45	55	8	7
35925	SN 25 E	45	55	8	7
14522	SN 25 E	45	55	11	10
15936	SNI 30 E	45	55	11	10
22938	SNI 39 E ZL	45	55	11	10
66363	SN 25 E	45	55	12	11
170895	SNI 39 E ZL	45	55	12.5	11.5
78609	SN 25 E	45	55	13	12
66364	SN 25 E	45	56	8	7
152586	SN 25 E	45	57.7	10.5	9.5
16074	SNI 30 E	45	57.7	10.5	9.5
68127	SNI 39 E ZL	45	57.7	10.5	9.5
171110	SNI 30 E	45	58	10	9
14523	SN 25 E	45	60	11	10
15937	SNI 30 E	45	60	11	10
78881	SNI 39 E ZL	45	60	11	10
16076	SNI 30 E	45	60	12.5	11.5
125083	SNI 39 E ZL	45	60	12.5	11.5
14698	SN 25 E	45	63	11	10
14524	SN 25 E	45	63	13	12
14699	SN 25 E	45	65	11	10
171111	SNI 30 E	45	65	11	10
89172	SNI 39 E ZL	45	65	11	10

Sizes

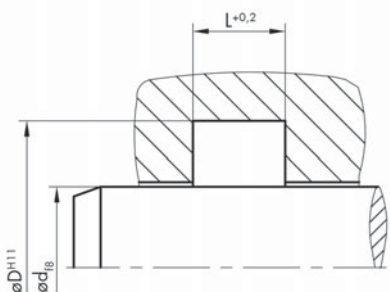

14525	SN 25 E	45	65	13	12
15938	SNI 30 E	45	65	13	12
68128	SNI 39 E ZL	45	65	13	12
16077	SNI 30 E	45	65	14.5	13.5
169219	SN 25 E	45	70	13	12
171112	SNI 30 E	46	56	8	7.5
158745	SNI 30 E	47	56	10	9
159153	SNI 39 E ZL	47.62	57.15	10.31	9.52
117569	SN 25 E	47.62	57.15	10.31	9.52
68129	SNI 39 E ZL	48	56	12.5	11.5
170896	SNI 39 E ZL	48	56	13	12
14526	SN 25 E	48	58	11	10
169152	SN 25 E	48	60	10	9
66378	SN 25 E	48	63	11	10
42379	SNI 39 E ZL	48	63	11	10
85881	SN 25 E	48	64	13	12
14527	SN 25 E	48	65	11	10
80323	SNI 39 E ZL	48	68	13	12
56008	SN 25 E	48	68	11	10
74275	SN 25 E	48	70	11	10
170897	SNI 39 E ZL	50	57	11	10
169139	SN 25 E	50	57	11	10
26574	SN 25 E	50	58	9	8
76449	SNI 39 E ZL	50	58	12.5	11.5
14528	SN 25 E	50	60	6	5
56453	SN 25 E	50	60	7	6
66379	SN 25 E	50	60	8	7.2
16079	SNI 30 E	50	60	8	7.2
125085	SNI 39 E ZL	50	60	8	7.3
133358	SNI 30 E	50	60	8	7
117423	SN 25 E	50	60	9	8
14432	SN 25 E	50	60	11	10
15939	SNI 30 E	50	60	11	10
80320	SNI 39 E ZL	50	60	11	10
14700	SN 25 E	50	60	12	11
14529	SN 25 E	50	60	13	12
171113	SNI 30 E	50	60	13	12
14731	SN 25 E	50	60	14	13
171114	SNI 30 E	50	62	9	8
14530	SN 25 E	50	62	10	9
80319	SNI 39 E ZL	50	62	11	10
171115	SNI 30 E	50	62.7	10.5	10
68135	SNI 39 E ZL	50	62.7	10.5	9.5
14531	SN 25 E	50	63	7	6
68342	SN 25 E	50	63	9	8
169175	SN 25 E	50	63	10	9
14532	SN 25 E	50	63	11	10
46913	SNI 39 E ZL	50	65	10.5	9.5
14411	SN 25 E	50	65	11	10
15940	SNI 30 E	50	65	11	10
68136	SNI 39 E ZL	50	65	11	10
46914	SNI 39 E ZL	50	65	12	11
16082	SNI 30 E	50	65	12.5	11.5
125086	SNI 39 E ZL	50	65	12.5	11.5
133261	SNI 30 E	50	65	12.5	11.4

SN 25/SNI 30/SNI 39

Sizes

Item No.	Code	d	D	L	H
169202	SN 25 E	50	65	13	12
68139	SNI 39 E ZL	50	65	16.5	15.5
171116	SNI 30 E	50	68	10	9
108747	SN 25 E	50	70	9	8
14533	SN 25 E	50	70	11	10
171117	SNI 30 E	50	70	11	10
14534	SN 25 E	50	70	13	12
15941	SNI 30 E	50	70	13	12
46915	SNI 39 E ZL	50	70	13	12
16085	SNI 30 E	50	70	14.5	13.5
170898	SNI 39 E ZL	50	70	15	14
14535	SN 25 E	50	70	19	18
110309	SN 25 E	50	72	11	10
57118	SN 25 E	50	74	16	15
159835	SN 25 E	50	75	9	8
14536	SN 25 E	50	75	13	12
159155	SNI 39 E ZL	50.8	57.15	7.14	6.35
162624	SN 25 E	50.8	60.32	7.14	6.35
159156	SNI 39 E ZL	50.8	60.32	7.14	6.35
162625	SN 25 E	50.8	60.32	8.72	7.93
159157	SNI 39 E ZL	50.8	60.32	8.72	7.93
66839	SN 25 E	50.8	60.32	10.31	9.52
159158	SNI 39 E ZL	50.8	60.32	10.31	9.52
159159	SNI 39 E ZL	50.8	63.5	7.14	6.35
159160	SNI 39 E ZL	50.8	63.5	8.72	7.93
36410	SN 25 E	50.8	63.5	10.31	9.52
125147	SNI 30 E	50.8	63.5	10.31	9.52
159161	SNI 39 E ZL	50.8	63.5	10.31	9.52
159162	SNI 39 E ZL	50.8	66.67	8.72	7.93
159163	SNI 39 E ZL	50.8	66.67	14.3	12.7
66848	SN 25 E	50.8	69.85	14.3	12.7
159164	SNI 39 E ZL	50.8	69.85	17.47	15.87
49540	SNI 30 E	52	62	11	10
80321	SNI 39 E ZL	52	62	11	10
14537	SN 25 E	52	62	13	12
67830	SN 25 E	53	63	6	5
14701	SN 25 E	53	63	7.5	6.5
126251	SN 25 E	53	63	11	10
133013	SN 25 E	53	63	13	12
159165	SNI 39 E ZL	53.97	63.5	10.31	9.52
67841	SN 25 E	54	72	11	10
68142	SNI 39 E ZL	55	62.5	10	9
56791	SNI 30 E	55	63	9	8
170899	SNI 39 E ZL	55	63	12.5	11.5
16086	SNI 30 E	55	63	13	12
28923	SNI 30 E	55	63	8.33	7.28
67833	SN 25 E	55	65	6	5
67834	SN 25 E	55	65	7	6
16087	SNI 30 E	55	65	8	7.2
170900	SNI 39 E ZL	55	65	9.5	9
14539	SN 25 E	55	65	11	10
15982	SNI 30 E	55	65	11	10
68145	SNI 39 E ZL	55	65	11	10
14540	SN 25 E	55	65	13	12
15942	SNI 30 E	55	65	13	12

Sizes

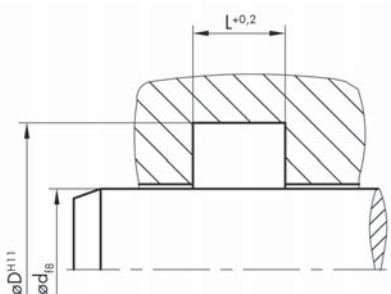

80322	SNI 39 E ZL	55	65	13	12
171118	SNI 30 E	55	65	14.5	13.5
16183	SNI 30 E	55	67	11	10
171119	SNI 30 E	55	68	11	10.5
68284	SN 25 E	55	70	9	8
117425	SN 25 E	55	70	11	10
15983	SNI 30 E	55	70	11	10
48501	SNI 39 E ZL	55	70	11	10
93332	SNI 30 E	55	70	11.5	10.6
14424	SN 25 E	55	70	13	12
15984	SNI 30 E	55	70	13	12
80325	SNI 39 E ZL	55	70	13	12
14417	SN 25 E	55	75	11	10
14541	SN 25 E	55	75	13	12
171120	SNI 30 E	55	75	13	12
80326	SNI 39 E ZL	55	75	13	12
16088	SNI 30 E	55	75	14.5	13.5
14542	SN 25 E	55	80	13	12
67853	SN 25 E	55	80	19	18
149572	SN 25 E	56	66	6	5
89987	SN 25 E	56	66	7.5	6.7
125034	SNI 30 E	56	66	9	8
15943	SNI 30 E	56	66	11	10
80327	SNI 39 E ZL	56	66	11	10
39173	SN 25 E	56	71	11	10
15944	SNI 30 E	56	71	11	10
80328	SNI 39 E ZL	56	71	11	10
16089	SNI 30 E	56	71	12.5	11.5
125088	SNI 39 E ZL	56	71	12.5	11.5
171121	SNI 30 E	56	76	13	12
80329	SNI 39 E ZL	56	76	13	12
171122	SNI 30 E	56	76	14.5	13.5
171123	SNI 30 E	56	76	16	15
170901	SNI 39 E ZL	57.1	66.7	10.5	10
170902	SNI 39 E ZL	57.1	69.8	10.5	10
68147	SNI 39 E ZL	57.15	66.67	10.31	9.52
36419	SN 25 E	57.15	69.85	10.31	9.52
68148	SNI 39 E ZL	57.15	69.85	10.31	9.52
125153	SNI 30 E	57.15	69.85	10.31	9.52
66854	SN 25 E	57.15	76.2	14.3	12.7
6412	SNI 39 E ZL	58	68	12.5	11.5
77713	SN 25 E	58	74	14	13
169232	SN 25 E	59	70	9	8
75394	SN 25 E	59	81	11	10
14543	SN 25 E	60	68	9	8
49411	SN 25 E	60	68	11	10
40622	SNI 39 E ZL	60	68	12.5	11.5
14544	SN 25 E	60	70	6	5
67839	SN 25 E	60	70	7	6
16092	SNI 30 E	60	70	8	7.2
80598	SNI 39 E ZL	60	70	8	7.5
14702	SN 25 E	60	70	9	8
14545	SN 25 E	60	70	11	10
15986	SNI 30 E	60	70	11	10
80324	SNI 39 E ZL	60	70	11	10

SN 25/SNI 30/SNI 39

Sizes

Item No.	Code	d	D	L	H
68152	SNI 39 E ZL	60	70	12.5	11.5
127080	SNI 30 E	60	70	12.8	11.8
14546	SN 25 E	60	70	13	12
15987	SNI 30 E	60	70	13	12
68153	SNI 39 E ZL	60	70	13	12
14732	SN 25 E	60	70	14	13
125692	SNI 30 E	60	70	14	13
171124	SNI 30 E	60	72	9	8
171125	SNI 30 E	60	72	10	9
127312	SNI 39 E ZL	60	72	11	10
82667	SN 25 E	60	75	9	8
14703	SN 25 E	60	75	11	10
15988	SNI 30 E	60	75	11	10
68154	SNI 39 E ZL	60	75	11	10
43028	SNI 30 E	60	75	12.5	11.5
86721	SNI 39 E ZL	60	75	12.5	11.5
14547	SN 25 E	60	75	13	12
15946	SNI 30 E	60	75	13	12
46917	SNI 39 E ZL	60	75	13	12
68155	SNI 39 E ZL	60	75	16.5	15.5
171126	SNI 30 E	60	77	12	11
14548	SN 25 E	60	80	11	10
14549	SN 25 E	60	80	13	12
15947	SNI 30 E	60	80	13	12
80331	SNI 39 E ZL	60	80	13	12
171127	SNI 30 E	60	80	14.5	13.5
14550	SN 25 E	60	80	19	18
67861	SN 25 E	60	85	11	10
72795	SN 25 E	60	85	13	12
169304	SN 25 E	60	85	13.5	12.5
14551	SN 25 E	60	90	16	15
159166	SNI 39 E ZL	60.32	69.85	10.31	9.52
159169	SNI 39 E ZL	60.32	73.02	10.31	9.52
150432	SNI 39 E ZL	60.32	73.02	8.73	7.54
171128	SNI 30 E	62	74	14	13
46541	SNI 30 E	62.8	72	10.8	9.8
29545	SN 25 E	63	73	6	5
171129	SNI 30 E	63	73	11	10
15948	SNI 30 E	63	73	13	12
46919	SNI 39 E ZL	63	73	13	12
116125	SNI 30 E	63	75	9.6	8.7
125953	SN 25 E	63	75	10	9
14705	SN 25 E	63	75	11	10
68157	SNI 39 E ZL	63	75	11	10
14554	SN 25 E	63	75	13	12
14555	SN 25 E	63	78	11	10
15949	SNI 30 E	63	78	11	10
80330	SNI 39 E ZL	63	78	11	10
16100	SNI 30 E	63	78	12.5	11.5
68173	SNI 39 E ZL	63	78	12.5	11.5
171130	SNI 30 E	63	78	13	12
67854	SN 25 E	63	80	10	9
46369	SN 25 E	63	80	11	10
15950	SNI 30 E	63	83	13	12
80334	SNI 39 E ZL	63	83	13	12

Sizes

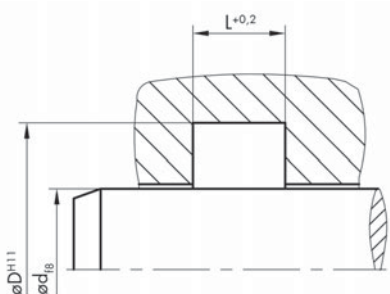

171131	SNI 30 E	63	83	14.5	13.5
68164	SNI 39 E ZL	63	83	14.5	13.5
14556	SN 25 E	63	83	16	15
16103	SNI 30 E	63	83	16	15
159171	SNI 39 E ZL	63.5	73.02	8.72	7.93
159174	SNI 39 E ZL	63.5	73.02	10.31	9.52
117504	SNI 30 E	63.5	74.6	8.72	7.93
159175	SNI 39 E ZL	63.5	76.2	7.14	6.35
36423	SN 25 E	63.5	76.2	10.31	9.52
68165	SNI 39 E ZL	63.5	76.2	10.31	9.52
80775	SNI 30 E	63.5	76.2	10.31	9.52
170903	SNI 39 E ZL	63.5	76.2	10.5	10
159177	SNI 39 E ZL	63.5	79.37	14.3	12.7
171042	SN 25 E	63.5	82.55	14.3	12.7
159178	SNI 39 E ZL	63.5	82.55	17.47	15.87
67855	SN 25 E	64	80	9	8
170904	SNI 39 E ZL	65	73	12.5	11.5
67846	SN 25 E	65	75	7	6
67847	SN 25 E	65	75	11	10
16184	SNI 30 E	65	75	11	10
170905	SNI 39 E ZL	65	75	11	10
80600	SNI 39 E ZL	65	75	12.5	11.5
14557	SN 25 E	65	75	13	12
15989	SNI 30 E	65	75	13	12
80921	SNI 39 E ZL	65	75	13	12
171133	SNI 30 E	65	75	14.5	13.5
171134	SNI 30 E	65	77	10	9
68167	SNI 39 E ZL	65	77.7	10.5	9.5
46040	SNI 30 E	65	78	11	10
157398	SNI 39 E ZL	65	78	11	10
35468	SN 25 E	65	80	11	10
171136	SNI 30 E	65	80	11	10
80333	SNI 39 E ZL	65	80	11	10
14706	SN 25 E	65	80	12	11
14426	SN 25 E	65	80	13	12
15991	SNI 30 E	65	80	13	12
80335	SNI 39 E ZL	65	80	13	12
14552	SN 25 E	65	85	11	10
14422	SN 25 E	65	85	13	12
15992	SNI 30 E	65	85	13	12
73974	SNI 39 E ZL	65	85	13	12
16106	SNI 30 E	65	85	14.5	13.5
67867	SN 25 E	65	90	13	12
67868	SN 25 E	65	90	19	18
169266	SN 25 E	66	76	9	8
14707	SN 25 E	66	80	11	10
170906	SNI 39 E ZL	66	80	11	10.5
159179	SNI 39 E ZL	66.67	76.2	10.31	9.52
159180	SNI 39 E ZL	66.67	79.37	14.3	12.7
159182	SNI 39 E ZL	66.67	82.55	17.47	15.87
68169	SNI 39 E ZL	67	75	12.5	11.5
65495	SN 25 E	67	77	11	10
14558	SN 25 E	67	77	13	12
90478	SN 25 E	68	78	13	12
170907	SNI 39 E ZL	69.8	82.5	10.5	10

SN 25/SNI 30/SNI 39

Sizes

Item No.	Code	d	D	L	H
159183	SNI 39 E ZL	69.85	79.37	10.31	9.52
80781	SNI 30 E	69.85	82.55	10.31	9.52
68170	SNI 39 E ZL	69.85	82.55	10.31	9.52
159184	SNI 39 E ZL	69.85	85.72	10.31	9.52
159185	SNI 39 E ZL	69.85	85.72	14.3	12.7
89882	SN 25 E	69.85	88.9	12.7	11.7
159186	SNI 39 E ZL	69.85	88.9	17.47	15.87
68171	SNI 39 E ZL	70	77.5	10	9
170908	SNI 39 E ZL	70	78	12.5	11.5
73782	SNI 30 E	70	78	13	12
77714	SN 25 E	70	78	14.5	13.5
68172	SNI 39 E ZL	70	79	14	13
67858	SN 25 E	70	80	6	5
22433	SNI 30 E	70	80	6.5	6
14559	SN 25 E	70	80	7	6
79749	SN 25 E	70	80	8	7
16107	SNI 30 E	70	80	8	7.2
14708	SN 25 E	70	80	9	8
14746	SN 25 E	70	80	11	10
16108	SNI 30 E	70	80	11	10
170909	SNI 39 E ZL	70	80	12.5	11.5
14412	SN 25 E	70	80	13	12
15951	SNI 30 E	70	80	13	12
22132	SNI 39 E ZL	70	80	13	12
116124	SNI 30 E	70	82	9.6	9
110382	SN 25 E	70	82	10.5	9.5
14560	SN 25 E	70	82	11	10
46911	SNI 30 E	70	83	11	10
169308	SN 25 E	70	85	11	10
15952	SNI 30 E	70	85	11	10
37968	SNI 39 E ZL	70	85	11	10
93334	SNI 30 E	70	85	11.5	10.6
16109	SNI 30 E	70	85	12.5	11.5
68177	SNI 39 E ZL	70	85	12.5	11.5
14425	SN 25 E	70	85	13	12
15953	SNI 30 E	70	85	13	12
118988	SNI 39 E ZL	70	85	13	12
35656	SN 25 E	70	90	11	10
14428	SN 25 E	70	90	13	12
15954	SNI 30 E	70	90	13	12
68179	SNI 39 E ZL	70	90	13	12
16110	SNI 30 E	70	90	14.5	13.5
16111	SNI 30 E	70	90	16	15
80338	SNI 39 E ZL	70	90	16	15
22389	SN 25 E	70	90	19	18
14709	SN 25 E	70	95	13	12
67880	SN 25 E	72	96	13	12
170910	SNI 39 E ZL	73	82.4	7.8	7.3
171139	SNI 30 E	73	82.5	8	7.5
159187	SNI 39 E ZL	73.02	82.55	10.31	9.52
68181	SNI 39 E ZL	75	83	12.5	11.5
16113	SNI 30 E	75	85	8	7.2
68182	SNI 39 E ZL	75	85	9.5	8.7
79748	SN 25 E	75	85	11	10
170911	SNI 39 E ZL	75	85	11	10.5

SN 25/SNI 30/SNI 39

Item No.	Code	d	D	L	H
68184	SNI 39 E ZL	75	85	12.5	11.5
14561	SN 25 E	75	85	13	12
15993	SNI 30 E	75	85	13	12
46922	SNI 39 E ZL	75	85	13	12
22684	SNI 30 E	75	87	9.6	8.6
14562	SN 25 E	75	90	8.5	7.5
67870	SN 25 E	75	90	10	9
66749	SN 25 E	75	90	11	10
15994	SNI 30 E	75	90	11	10
80336	SNI 39 E ZL	75	90	11	10
14563	SN 25 E	75	90	13	12
15995	SNI 30 E	75	90	13	12
80337	SNI 39 E ZL	75	90	13	12
67877	SN 25 E	75	95	11	10
14564	SN 25 E	75	95	13	12
171140	SNI 30 E	75	95	13	12
16115	SNI 30 E	75	95	14.5	13.5
14565	SN 25 E	75	100	16	15
72961	SNI 30 E	75	105	23.5	22.5
16116	SNI 30 E	76	84	8.5	7.5
159188	SNI 39 E ZL	76.2	85.72	10.31	9.52
36425	SN 25 E	76.2	88.9	10.31	9.52
68186	SNI 39 E ZL	76.2	88.9	10.31	9.52
170912	SNI 39 E ZL	76.2	88.9	10.5	10
159189	SNI 39 E ZL	76.2	88.9	17.47	15.87
159190	SNI 39 E ZL	76.2	92.07	14.3	12.7
159191	SNI 39 E ZL	76.2	95.25	17.47	15.87
69616	SN 25 E	76.2	101.6	14.3	12.7
68187	SNI 39 E ZL	77	86	15	14
61440	SNI 39 E ZL	78	86	12.5	11.5
68189	SNI 39 E ZL	78	86	14.5	13.5
170913	SNI 39 E ZL	78	88	13	12
170914	SNI 39 E ZL	78	90	13	12.5
169334	SN 25 E	78	93	11.5	10.5
74956	SN 25 E	78	100	16	15
68191	SNI 39 E ZL	79.37	88.9	10.31	9.52
159192	SNI 39 E ZL	79.37	88.9	17.47	15.87
170915	SNI 39 E ZL	79.4	88.9	10.5	10
170916	SNI 39 E ZL	80	88	12.5	11.5
14566	SN 25 E	80	90	6	5
67871	SN 25 E	80	90	7	6
16117	SNI 30 E	80	90	8	7.2
67872	SN 25 E	80	90	9	8
14567	SN 25 E	80	90	11	10
73786	SNI 30 E	80	90	11	10.5
14568	SN 25 E	80	90	13	12
15955	SNI 30 E	80	90	13	12
22965	SNI 39 E ZL	80	90	13	12
79750	SN 25 E	80	90	14.5	13.5
156390	SNI 39 E ZL	80	90	14.5	13.5
171141	SNI 30 E	80	90	15	14
80850	SNI 30 E	80	92	9.6	8.6
46154	SNI 30 E	80	93	11	10
169339	SN 25 E	80	95	10	9
69135	SNI 30 E	80	95	10	9

Sizes

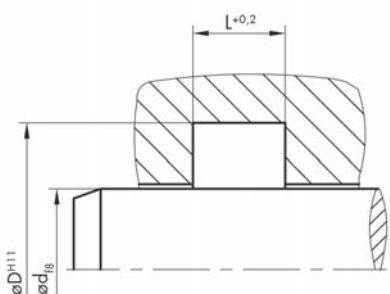

SN 25/SNI 30/SNI 39

Sizes

Item No.	Code	d	D	L	H
15956	SNI 30 E	80	95	11	10
59321	SNI 39 E ZL	80	95	11	10
16119	SNI 30 E	80	95	12.5	11.5
80610	SNI 39 E ZL	80	95	12.5	11.5
14427	SN 25 E	80	95	13	12
15957	SNI 30 E	80	95	13	12
80340	SNI 39 E ZL	80	95	13	12
14420	SN 25 E	80	100	11	10
14429	SN 25 E	80	100	13	12
15958	SNI 30 E	80	100	13	12
80341	SNI 39 E ZL	80	100	13	12
16120	SNI 30 E	80	100	14.5	13.5
171142	SNI 30 E	80	100	16	15
80342	SNI 39 E ZL	80	100	16	15
14569	SN 25 E	80	100	19	18
118745	SN 25 E	80	105	13	12
22385	SN 25 E	82	92	11	10
170917	SNI 39 E ZL	82.5	97.5	13	12.5
159193	SNI 39 E ZL	82.55	92.07	10.31	9.52
159194	SNI 39 E ZL	82.55	92.07	15.72	14.28
89892	SNI 39 E ZL	82.55	95.25	10.31	9.52
159195	SNI 39 E ZL	82.55	98.42	14.3	12.7
117390	SNI 30 E	82.55	98.5	14	13
70364	SN 25 E	83	98	14.5	13.5
73180	SN 25 E	84	100	14.5	13.5
68194	SNI 39 E ZL	85	92.5	10	9
37769	SNI 39 E ZL	85	93	12.5	11.5
73789	SNI 30 E	85	94	15	14
106964	SNI 30 E	85	95	7	6
171143	SNI 30 E	85	95	8	7.2
14712	SN 25 E	85	95	9.5	8.5
74294	SN 25 E	85	95	10.5	9.5
14570	SN 25 E	85	95	13	12
80800	SNI 30 E	85	95	13	12
118556	SN 25 E	85	100	9	8
56452	SN 25 E	85	100	10	9
80577	SN 25 E	85	100	12	11
171144	SNI 30 E	85	100	12	11
76464	SNI 30 E	85	100	12.5	11.5
125091	SNI 39 E ZL	85	100	12.5	11.5
14571	SN 25 E	85	100	13	12
15996	SNI 30 E	85	100	13	12
89157	SNI 39 E ZL	85	100	13	12
67885	SN 25 E	85	100	26	25
14572	SN 25 E	85	105	13	12
171145	SNI 30 E	85	105	13	12
80343	SNI 39 E ZL	85	105	13	12
16124	SNI 30 E	85	105	14.5	13.5
67892	SN 25 E	85	105	19	18
67898	SN 25 E	85	110	13	12
169396	SN 25 E	85	115	16	15
106963	SNI 30 E	88	98	7.5	6.5
159196	SNI 39 E ZL	88.9	98.42	10.31	9.52
159197	SNI 39 E ZL	88.9	101.6	8.72	7.93
66883	SN 25 E	88.9	101.6	10.31	9.52

SN 25/SNI 30/SNI 39

Item No.	Code	d	D	L	H
68195	SNI 39 E ZL	88.9	101.6	10.31	9.52
170918	SNI 39 E ZL	88.9	101.6	10.5	10
75135	SN 25 E	88.9	104.77	8.72	7.93
159198	SNI 39 E ZL	88.9	104.77	14.3	12.7
159199	SNI 39 E ZL	88.9	107.95	17.47	15.87
170919	SNI 39 E ZL	90	98	12.5	11.5
34725	SN 25 E	90	100	6	5
22416	SN 25 E	90	100	8	7
170921	SNI 39 E ZL	90	100	8	7.5
14714	SN 25 E	90	100	9	8
170920	SNI 39 E ZL	90	100	10	9
157381	SN 25 E	90	100	11	10
4854	SNI 30 E	90	100	11	10
148993	SNI 39 E ZL	90	100	11	10
171146	SNI 30 E	90	100	12.5	11.5
68196	SNI 39 E ZL	90	100	12.5	11.5
14421	SN 25 E	90	100	13	12
124684	SNI 39 E ZL	90	100	13	12
125043	SNI 30 E	90	102	10	9
16126	SNI 30 E	90	105	9.5	8.5
67893	SN 25 E	90	105	10	9
22434	SNI 30 E	90	105	10.5	9.5
46039	SNI 30 E	90	105	11	10
16127	SNI 30 E	90	105	12.5	11.5
68197	SNI 39 E ZL	90	105	12.5	11.5
14573	SN 25 E	90	105	13	12
15959	SNI 30 E	90	105	13	12
22361	SNI 39 E ZL	90	105	13	12
67899	SN 25 E	90	110	11	10
14574	SN 25 E	90	110	13	12
15960	SNI 30 E	90	110	13	12
68198	SNI 39 E ZL	90	110	13	12
16128	SNI 30 E	90	110	16	15
14575	SN 25 E	90	110	19	18
42513	SN 25 E	90	115	13	12
14576	SN 25 E	90	115	16	15
66740	SN 25 E	90	115	23	22
169408	SN 25 E	90	120	16	15
171147	SNI 30 E	91	99	8.5	8
159200	SNI 39 E ZL	92.07	104.77	10.31	9.52
7483	SNI 39 E ZL	93	101	12.5	11.5
169573	SNI 30 E	93	104	11	10.5
170922	SNI 39 E ZL	95	103	12.5	11.5
37768	SNI 39 E ZL	95	103	13	12
170923	SNI 39 E ZL	95	105	9.5	9
169571	SNI 30 E	95	105	11	10
14577	SN 25 E	95	105	13	12
169157	SNI 30 E	95	105	13	12
68201	SNI 39 E ZL	95	105	13	12
67900	SN 25 E	95	110	10	9
125045	SNI 30 E	95	110	10	9
117432	SN 25 E	95	110	11	10
14414	SN 25 E	95	110	13	12
43053	SNI 30 E	95	110	13	12
14715	SN 25 E	95	110	16	15

Sizes

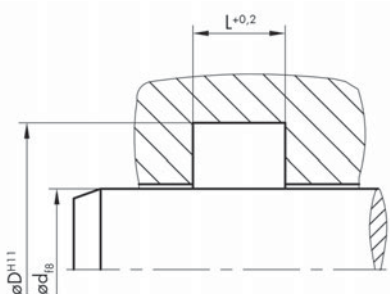

SN 25/SNI 30/SNI 39

Sizes

Item No.	Code	d	D	L	H
169394	SN 25 E	95	112	12	11
14578	SN 25 E	95	115	13	12
16131	SNI 30 E	95	115	13	12
118863	SNI 39 E ZL	95	115	13	12
14717	SN 25 E	95	115	19	18
159201	SNI 39 E ZL	95.25	104.77	10.31	9.52
159202	SNI 39 E ZL	95.25	107.95	10.31	9.52
159203	SNI 39 E ZL	95.25	107.95	14.3	12.7
159204	SNI 39 E ZL	95.25	107.95	15.72	14.28
15484	SN 25 E	96	105	12	11
170924	SNI 39 E ZL	97	105	12.5	11.5
68203	SNI 39 E ZL	97	105	14.5	13.5
170925	SNI 39 E ZL	97	106	15	14
14580	SN 25 E	98	108	11	10
170926	SNI 39 E ZL	99	109	13	12.5
170927	SNI 39 E ZL	100	108	12.5	11.5
77490	SN 25 E	100	110	6	5
169392	SN 25 E	100	110	9	8
170929	SNI 39 E ZL	100	110	11	10.5
170928	SNI 39 E ZL	100	110	12.5	11.5
169360	SNI 30 E	100	110	15	14
160456	SNI 39 E ZL	100	110	15	14
169359	SNI 30 E	100	113	13.5	13
67901	SN 25 E	100	115	10	9
169403	SNI 30 E	100	115	10	9
125046	SNI 30 E	100	115	11	10
16133	SNI 30 E	100	115	11.5	10.5
80238	SNI 30 E	100	115	12	11
14581	SN 25 E	100	115	13	12
15961	SNI 30 E	100	115	13	12
80349	SNI 39 E ZL	100	115	13	12
44858	SN 25 E	100	120	11	10
93317	SNI 30 E	100	120	12.5	11.5
14582	SN 25 E	100	120	13	12
15962	SNI 30 E	100	120	13	12
80350	SNI 39 E ZL	100	120	13	12
169402	SNI 30 E	100	120	14.5	13.5
14583	SN 25 E	100	120	16	15
15963	SNI 30 E	100	120	16	15
80351	SNI 39 E ZL	100	120	16	15
80612	SNI 39 E ZL	100	120	16	14.5
14733	SN 25 E	100	120	19	18
14642	SN 25 E	100	125	13	12
14584	SN 25 E	100	125	16	15
80346	SNI 39 E ZL	100	125	16	15
169458	SNI 30 E	100	125	20	19
22667	SN 25 E	100	130	13	12
169431	SN 25 E	100	130	16	15
36641	SN 25 E	100	130	19	18
72962	SN 25 E	100	135	17	16
159205	SNI 39 E ZL	101.6	111.12	10.31	9.52
125388	SNI 30 E	101.6	111.12	10.31	9.52
159206	SNI 39 E ZL	101.6	114.3	8.72	7.93
159207	SNI 39 E ZL	101.6	114.3	10.31	9.52
159208	SNI 39 E ZL	101.6	114.3	15.72	14.28

Sizes

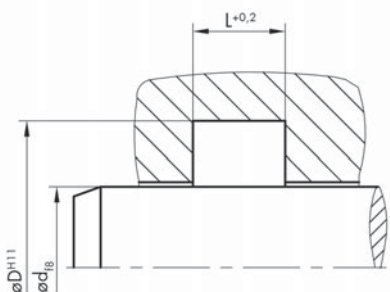

159209	SNI 39 E ZL	101.6	117.47	10.31	9.52
159210	SNI 39 E ZL	101.6	117.47	14.3	12.7
159211	SNI 39 E ZL	101.6	120.65	14.3	12.7
159212	SNI 39 E ZL	101.6	120.65	17.47	15.87
7515	SN 25 E	104	110	13	12
170931	SNI 39 E ZL	105	113	12.5	11.5
170930	SNI 39 E ZL	105	113	14.5	13.5
169457	SNI 30 E	105	115	11	10
169546	SNI 30 E	105	115	12.5	11.5
68211	SNI 39 E ZL	105	115	12.5	11.5
169545	SNI 30 E	105	115	14.5	13.5
161798	SNI 30 E	105	117	11	10
14748	SN 25 E	105	120	9	8
59451	SNI 39 E ZL	105	120	10.9	9.9
169542	SNI 30 E	105	120	13	12
14718	SN 25 E	105	120	16	15
15964	SNI 30 E	105	120	16	15
78529	SN 25 E	105	125	11	10
14749	SN 25 E	105	125	13	12
169541	SNI 30 E	105	125	13	12
66751	SN 25 E	105	125	15	14
14585	SN 25 E	105	125	16	15
159836	SN 25 E	105	130	13	12
66752	SN 25 E	106	120	9.5	8.5
134964	SNI 30 E	106	120	10.5	9.5
119006	SNI 30 E	107	117	7	6
159213	SNI 39 E ZL	107.95	127	17.47	15.87
170932	SNI 39 E ZL	110	118	12.5	11.5
119007	SNI 30 E	110	120	7	6
73794	SNI 30 E	110	120	13	12
80355	SNI 39 E ZL	110	120	13	12
125048	SNI 30 E	110	125	10.6	9.6
16139	SNI 30 E	110	125	12	11
14719	SN 25 E	110	125	13	12
134400	SNI 39 E ZL	110	125	13	12
14431	SN 25 E	110	125	16	15
169547	SNI 30 E	110	125	16	15
22363	SNI 39 E ZL	110	125	16	15
149573	SN 25 E	110	130	11	10
67906	SN 25 E	110	130	13	12
15966	SNI 30 E	110	130	13	12
80356	SNI 39 E ZL	110	130	13	12
14586	SN 25 E	110	130	16	15
15967	SNI 30 E	110	130	16	15
80357	SNI 39 E ZL	110	130	16	15
80358	SNI 39 E ZL	110	130	16	14.5
14720	SN 25 E	110	130	19	18
80354	SNI 39 E ZL	110	135	16	15
169449	SN 25 E	110	135	19	18
169538	SNI 30 E	110	135	20	19
117436	SN 25 E	110	140	19	18
170933	SNI 39 E ZL	112	122	11	10.5
170934	SNI 39 E ZL	113	123	9.5	9
14721	SN 25 E	113	125	10.5	9.5
159214	SNI 39 E ZL	114.3	127	10.31	9.52

SN 25/SNI 30/SNI 39

Sizes

Item No.	Code	d	D	L	H
73197	SN 25 E	114.3	127	16	14.5
75137	SN 25 E	114.3	130.17	10.31	9.52
159215	SNI 39 E ZL	114.3	130.17	14.3	12.7
159216	SNI 39 E ZL	114.3	130.17	17.47	15.87
159217	SNI 39 E ZL	114.3	133.35	17.47	15.87
68228	SNI 39 E ZL	115	123	12.5	11.5
68229	SNI 39 E ZL	115	125	13	12
170935	SNI 39 E ZL	115	125	15	14
171050	SN 25 E	115	125	16	15
171051	SN 25 E	115	126	16	15
169441	SN 25 E	115	130	11	10
170936	SNI 39 E ZL	115	130	11	10.5
14589	SN 25 E	115	130	16	15
67909	SN 25 E	115	135	13	12
169537	SNI 30 E	115	135	13	12
14590	SN 25 E	115	135	16	15
21683	SN 25 E	115	140	16	15
80360	SNI 39 E ZL	115	140	16	15
14750	SN 25 E	115	140	23	22
158712	SN 25 E	115	145	19	18
68230	SNI 39 E ZL	117	126	15	14
159219	SNI 39 E ZL	117.47	133.35	17.47	15.87
64739	SNI 39 E ZL	118	126	12.5	11.5
68232	SNI 39 E ZL	118	126	14.5	13.5
68233	SNI 39 E ZL	120	128	12.5	11.5
67907	SN 25 E	120	130	6	5
169552	SNI 30 E	120	130	8	7.2
16143	SNI 30 E	120	130	12.5	11.5
68234	SNI 39 E ZL	120	130	12.5	11.5
170937	SNI 39 E ZL	120	130	13	12
156396	SNI 39 E ZL	120	130	14.5	13.5
169445	SN 25 E	120	130	15	14
169564	SNI 30 E	120	132	11	10.5
169563	SNI 30 E	120	135	12.5	11.5
14591	SN 25 E	120	135	16	15
15998	SNI 30 E	120	135	16	15
77703	SNI 39 E ZL	120	135	16	15
14592	SN 25 E	120	140	11	10
72796	SN 25 E	120	140	13	12
15999	SNI 30 E	120	140	13	12
80359	SNI 39 E ZL	120	140	13	12
14593	SN 25 E	120	140	16	15
16000	SNI 30 E	120	140	16	15
22134	SNI 39 E ZL	120	140	16	15
67919	SN 25 E	120	150	16	15
159220	SNI 39 E ZL	120.65	130.17	10.31	9.52
159221	SNI 39 E ZL	120.65	130.17	17.47	15.87
68236	SNI 39 E ZL	121	135	10	9
76472	SNI 39 E ZL	125	133	12.5	11.5
170938	SNI 39 E ZL	125	135	11	10
171155	SNI 30 E	125	135	14.5	13.5
160457	SNI 39 E ZL	125	135	14.5	13.5
14723	SN 25 E	125	140	12	11
67911	SN 25 E	125	140	13	12
14594	SN 25 E	125	140	16	15

SN 25/SNI 30/SNI 39

Item No. Code d D L H

Sizes

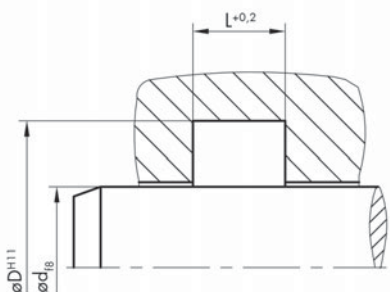

149574	SN 25 E	125	145	11	10
15969	SNI 30 E	125	145	13	12
80361	SNI 39 E ZL	125	145	13	12
14595	SN 25 E	125	145	16	15
15968	SNI 30 E	125	145	16	15
80365	SNI 39 E ZL	125	145	16	15
169469	SN 25 E	125	145	19	18
67920	SN 25 E	125	150	13	12
171156	SNI 30 E	125	150	15	14
80367	SNI 39 E ZL	125	150	16	15
171157	SNI 30 E	125	150	20	19
14751	SN 25 E	125	155	16	15
15970	SNI 30 E	125	155	19	18
80369	SNI 39 E ZL	125	155	19	18
22691	SNI 30 E	127	139.7	10	9.2
159222	SNI 39 E ZL	127	139.7	10.31	9.52
159223	SNI 39 E ZL	127	139.7	15.72	14.28
159224	SNI 39 E ZL	127	142.87	14.3	12.7
75136	SN 25 E	127	146.05	10.31	9.52
159225	SNI 39 E ZL	127	146.05	17.47	15.87
170939	SNI 39 E ZL	128	136	12.5	11.5
160557	SNI 30 E	128	140	11	10
170940	SNI 39 E ZL	130	138	12.5	11.5
16147	SNI 30 E	130	140	8	7.2
171158	SNI 30 E	130	140	14.5	13.5
160458	SNI 39 E ZL	130	140	14.5	13.5
6550	SNI 30 E	130	145	13	12
16148	SNI 30 E	130	145	15	14
16149	SNI 30 E	130	145	16	15
67921	SN 25 E	130	150	11	10
171159	SNI 30 E	130	150	13	12
80362	SNI 39 E ZL	130	150	13	12
14598	SN 25 E	130	150	16	15
16002	SNI 30 E	130	150	16	15
80363	SNI 39 E ZL	130	150	16	15
169488	SN 25 E	130	160	19	18
159226	SNI 39 E ZL	130.17	142.87	15.72	14.28
159227	SNI 39 E ZL	130.17	152.4	14.3	12.7
76473	SNI 39 E ZL	131	150	14	13
68238	SNI 39 E ZL	132	142	9.5	8.7
170941	SNI 39 E ZL	135	143	12.5	11.5
124685	SNI 39 E ZL	135	145	13	12
68301	SNI 39 E ZL	135	150	12.5	11.5
14599	SN 25 E	135	150	16	15
170942	SNI 39 E ZL	135	150	16	15
14600	SN 25 E	135	155	16	15
14755	SN 25 E	135	160	16	15
95552	SN 25 E	136	146	7	6
159228	SNI 39 E ZL	136.52	149.22	17.47	15.87
159229	SNI 39 E ZL	136.52	152.4	17.47	15.87
68303	SNI 39 E ZL	137	146	15	14
72400	SN 25 E	138	158	13	12
159231	SNI 39 E ZL	139.7	152.4	10.31	9.52
66913	SN 25 E	139.7	152.4	10.31	9.52
159230	SNI 39 E ZL	139.7	152.4	15.72	14.28

Item No.	Code	d	D	L	H
159232	SNI 39 E ZL	139.7	155.57	8.72	7.93
159233	SNI 39 E ZL	139.7	158.75	17.47	15.87
170943	SNI 39 E ZL	140	148	12.5	11.5
67923	SN 25 E	140	150	6	5
11660	SNI 30 E	140	150	7	6
171160	SNI 30 E	140	150	12.5	11.5
68305	SNI 39 E ZL	140	150	12.5	11.5
158613	SN 25 E	140	150	16	15
16151	SNI 30 E	140	155	13	12
46129	SN 25 E	140	155	16	15
88187	SNI 30 E	140	155.5	7	6
169491	SN 25 E	140	160	11	10
14603	SN 25 E	140	160	13	12
15971	SNI 30 E	140	160	13	12
80314	SNI 39 E ZL	140	160	13	12
14604	SN 25 E	140	160	16	15
15972	SNI 30 E	140	160	16	15
80364	SNI 39 E ZL	140	160	16	15
80353	SNI 39 E ZL	140	165	16	15
16153	SNI 30 E	140	165	20	19
90269	SN 25 E	140	170	16	15
80332	SNI 39 E ZL	140	170	19	18
170944	SNI 39 E ZL	141	151	13	12.5
95551	SN 25 E	142	152	7	6
159234	SNI 39 E ZL	142.87	155.57	10.31	9.52
68308	SNI 39 E ZL	143	151	12.5	11.5
68309	SNI 39 E ZL	143	151	14.5	13.5
170945	SNI 39 E ZL	145	155	13	12.5
76474	SNI 30 E	145	157.7	10	9
46376	SN 25 E	145	160	10	9
170946	SNI 39 E ZL	145	160	13	12
14605	SN 25 E	145	165	16	15
157747	SN 25 E	146	160	10	9
34853	SN 25 E	146	170	15	14
171161	SNI 30 E	147	160	13	12.5
73798	SNI 30 E	150	160	14.5	13.5
160459	SNI 39 E ZL	150	160	14.5	13.5
16156	SNI 30 E	150	170	13	12
16157	SNI 30 E	150	170	14.5	13.5
22136	SNI 39 E ZL	150	170	15.5	14.5
14606	SN 25 E	150	170	16	15
16003	SNI 30 E	150	170	16	15
80345	SNI 39 E ZL	150	170	16	15
14607	SN 25 E	150	170	19	18
169511	SN 25 E	150	180	16	15
80348	SNI 39 E ZL	150	180	19	18
67933	SN 25 E	150	180	19	18
171643	SNI 39 E ZL	152	160	12.5	11.5
171642	SNI 39 E ZL	152	162	11	10.5
160558	SNI 30 E	152	164	11	10
171641	SNI 39 E ZL	152	171	12.5	11.5
159235	SNI 39 E ZL	152.4	165.1	15.72	14.28
159236	SNI 39 E ZL	152.4	171.45	17.47	15.87
36435	SN 25 E	152.4	177.8	14.3	12.7
171640	SNI 39 E ZL	152.5	160.5	15	14

SN 25/SNI 30/SNI 39

Item No. Code d D L H

Sizes

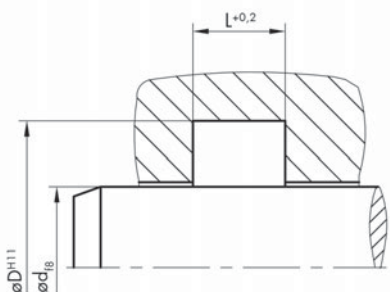

171639	SNI 39 E ZL	155	163	12.5	11.5
93372	SNI 30 E	155	165	7	6
88188	SNI 30 E	155	170.5	7	6
14608	SN 25 E	155	175	16	15
46381	SN 25 E	155	180	16	15
69589	SNI 39 E ZL	160	168	12.5	11.5
64960	SNI 30 E	160	169	14.5	13.5
149576	SN 25 E	160	170	6	5
69590	SNI 39 E ZL	160	170	12.5	11.5
171162	SNI 30 E	160	170	13	12
124687	SNI 39 E ZL	160	170	13	12
38529	SN 25 E	160	175	8.5	7.5
45519	SN 25 E	160	175	16	15
171163	SNI 30 E	160	180	13	12
14609	SN 25 E	160	180	16	15
15973	SNI 30 E	160	180	16	15
22137	SNI 39 E ZL	160	180	16	15
121450	SNI 30 E	160	184	16	15
46383	SN 25 E	160	185	16	15
80240	SNI 30 E	160	185	16	15
80370	SNI 39 E ZL	160	185	16	15
80607	SNI 39 E ZL	160	185	20	18.2
149263	SN 25 E	160	190	13	12
67935	SN 25 E	160	190	16	15
35465	SNI 30 E	160	190	19	18
80371	SNI 39 E ZL	160	190	19	18
149190	SN 25 E	160	190	19	18
156842	SN 25 E	160	190	20	19
69592	SNI 39 E ZL	162	172	13	12
171638	SNI 39 E ZL	165	184	14	13
46384	SN 25 E	165	190	16	15
83617	SNI 39 E ZL	165	190	18	17
22685	SNI 30 E	165	195	21	20
159237	SNI 39 E ZL	165.1	184.15	17.47	15.87
171637	SNI 39 E ZL	170	178	12.5	11.5
171636	SNI 39 E ZL	170	180	13	12.5
117393	SNI 30 E	170	180	15.5	14.5
69425	SN 25 E	170	183	9.5	8.5
121430	SN 25 E	170	185	16	14.7
171164	SNI 30 E	170	190	13	12
14610	SN 25 E	170	190	16	15
16004	SNI 30 E	170	190	16	15
80590	SNI 39 E ZL	170	190	16	15
36240	SN 25 E	170	195	16	15
169530	SN 25 E	170	200	16	15
21108	SN 25 E	170	200	19	18
37038	SNI 39 E ZL	170	200	19	18
79562	SN 25 E	170	215	21	20
171634	SNI 39 E ZL	175	185	13	12.5
121902	SN 25 E	175	187	10.5	9.5
14756	SN 25 E	175	200	16	15
124160	SN 25 E	175	215	21	20
171633	SNI 39 E ZL	177	205	20	19
159238	SNI 39 E ZL	177.8	190.5	15.72	14.28
159239	SNI 39 E ZL	177.8	196.85	17.47	15.87

SN 25/SNI 30/SNI 39

Sizes

Item No.	Code	d	D	L	H
69599	SNI 39 E ZL	180	188	14.5	13.5
71118	SNI 39 E ZL	180	190	11	10
160559	SNI 30 E	180	192	11	10
71119	SNI 39 E ZL	180	195	13.5	12.5
171165	SNI 30 E	180	200	13	12
14430	SN 25 E	180	200	16	15
15974	SNI 30 E	180	200	16	15
80372	SNI 39 E ZL	180	200	16	15
75768	SN 25 E	180	200	19	18
16161	SNI 30 E	180	200	20	19
125053	SNI 30 E	180	205	16	15
80591	SNI 39 E ZL	180	205	16	15
80592	SNI 39 E ZL	180	205	20	19
80593	SNI 39 E ZL	180	210	19	18
37476	SNI 30 E	180	210	19	18
117402	SN 25 E	180	210	23	22
14752	SN 25 E	180	220	21	20
84196	SN 25 E	182	200	26	25
171632	SNI 39 E ZL	185	193	12.5	11.5
67936	SN 25 E	185	200	8.5	7.5
14612	SN 25 E	185	205	16	15
171166	SNI 30 E	190	210	13	12.5
14613	SN 25 E	190	210	16	15
16163	SNI 30 E	190	210	16	15
79758	SN 25 E	190	220	16	15
7650	SN 25 E	190	220	19	18
67943	SN 25 E	190	220	27	26
130250	SN 25 E	190	320	23	22
159240	SNI 39 E ZL	190.5	203.2	10.31	9.52
159241	SNI 39 E ZL	196.85	215.9	17.47	15.87
171167	SNI 30 E	198	207.6	7.5	7
171631	SNI 39 E ZL	200	208	12.5	11.5
171168	SNI 30 E	200	212	16	15
67944	SN 25 E	200	220	11	10
16164	SNI 30 E	200	220	13	12
14616	SN 25 E	200	220	16	15
171169	SNI 30 E	200	220	16	15
46841	SNI 39 E ZL	200	220	16	15
171170	SNI 30 E	200	225	16	15
72443	SN 25 E	200	225	16	15
169556	SN 25 E	200	225	19	18
16165	SNI 30 E	200	225	20	19
80594	SNI 39 E ZL	200	225	20	19
173381	SN 25 E	200	230	16	15
14617	SN 25 E	200	230	18	17
80595	SNI 39 E ZL	200	230	19	18
14725	SN 25 E	200	230	19	18
126460	SNI 30 E	200	230	19	18
90420	SN 25 E	200	230	23	22
71368	SN 25 E	200	235	10	9
124163	SN 25 E	200	235	21	20
81202	SN 25 E	200	240	16	15
159242	SNI 39 E ZL	203.2	215.9	10.31	9.52
159243	SNI 39 E ZL	203.2	215.9	15.72	14.28
159244	SNI 39 E ZL	203.2	222.25	17.47	15.87

Sizes

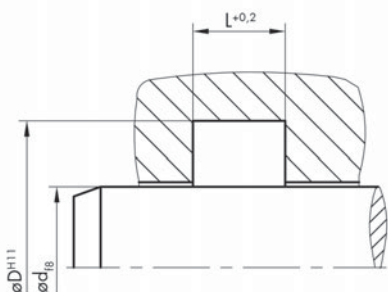

69591	SNI 39 E ZL	205	220	13.5	12.5
38196	SN 25 E	205	235	19	18
71121	SNI 39 E ZL	209	228	14	13
171171	SNI 30 E	210	230	13	12
16005	SNI 30 E	210	230	16	15
80596	SNI 39 E ZL	210	230	16	15
81201	SN 25 E	210	230	16	15
171628	SNI 30 E	210	235	26	25
14618	SN 25 E	210	240	19	18
80373	SNI 39 E ZL	210	240	19	18
155862	SNI 30 E	210	240	23	22
171630	SNI 39 E ZL	212	220	14.5	13.5
160560	SNI 30 E	212	224	11	10
30462	SN 25 E	212	237	19	18
77344	SNI 30 E	213	242.7	19	18
82413	SN 25 E	215	245	19	18
159245	SNI 39 E ZL	215.9	228.6	10.31	9.52
72595	SN 25 E	220	235	10	9
171172	SNI 30 E	220	240	13	12.5
15976	SNI 30 E	220	240	16	15
67948	SN 25 E	220	240	16	15
27552	SN 25 E	220	250	16	15
14619	SN 25 E	220	250	19	18
80374	SNI 39 E ZL	220	250	19	18
124165	SN 25 E	220	250	21	20
90271	SN 25 E	220	260	21	20
169583	SN 25 E	225	245	16	15
159246	SNI 39 E ZL	228.6	241.3	15.72	14.28
16168	SNI 30 E	230	250	13	12
14621	SN 25 E	230	250	16	15
7806	SNI 30 E	230	260	25	23.6
171629	SNI 39 E ZL	232	246	13	12.5
71367	SN 25 E	235	247	10	9
46928	SNI 30 E	235	255	13	12
46395	SN 25 E	236	261	19	18
16169	SNI 30 E	240	260	13	12
76156	SN 25 E	240	260	13	12
16006	SNI 30 E	240	260	16	15
14622	SN 25 E	240	260	18	17
46398	SN 25 E	240	265	19	18
116836	SN 25 E	240	268	19	18
14734	SN 25 E	240	270	16	15
16007	SNI 30 E	240	270	19	18
14623	SN 25 E	240	270	19	18
155863	SNI 30 E	240	270	23	22
90270	SN 25 E	240	280	21	20
82769	SN 25 E	240	290	19	18
82231	SN 25 E	245	265	16	15
171625	SN 25 E	245	270	16	15
16170	SNI 30 E	250	270	13	12
15978	SNI 30 E	250	270	16	15
80601	SNI 39 E ZL	250	270	16	15
89364	SN 25 E	250	270	17	16
130249	SN 25 E	250	280	19	18
85651	SN 25 E	250	280	20	19

SN 25/SNI 30/SNI 39

Sizes

Item No.	Code	d	D	L	H
14625	SN 25 E	250	280	23	22
171627	SNI 30 E	250	280	23	22
90340	SN 25 E	260	280	16	15
10019	SNI 30 E	260	280	16	15
124168	SN 25 E	260	290	19	18
79760	SN 25 E	260	300	21	20
76481	SN 25 E	265	290	18	17
22827	SN 25 E	270	290	18	17
14626	SN 25 E	270	300	16	15
16171	SNI 30 E	270	300	19	18
130253	SN 25 E	270	300	23	22
22417	SN 25 E	280	300	16	15
36695	SNI 30 E	280	300	16	15
16172	SNI 30 E	280	305	16	15
30585	SN 25 E	280	310	19	18
16173	SNI 30 E	280	310	25	24
14628	SN 25 E	290	310	13	12
130436	SN 25 E	290	320	22	21
130510	SN 25 E	290	320	23	22
27296	SN 25 E	295	320	19	18
84949	SN 25 E	300	320	16	15
86441	SN 25 E	300	330	19	18
14629	SN 25 E	300	330	23	22
76519	SN 25 E	304.8	338.25	26.59	25.4
76528	SN 25 E	304.8	343.8	26.59	25.4
77574	SN 25 E	304.8	344.6	26.59	25.4
76483	SN 25 E	305	320	18	17
14630	SN 25 E	310	330	18	17
108582	SN 25 E	320	340	16	15
67961	SN 25 E	320	350	16	15
14634	SN 25 E	320	350	17	16
80377	SNI 39 E ZL	320	350	21	20
107851	SN 25 E	320	350	23.5	22.5
73367	SN 25 E	320	350	27	26
79761	SN 25 E	320	360	21	20
82766	SN 25 E	320	360	29	28
74123	SN 25 E	328	380	31	30
81203	SN 25 E	330	360	21	20
45445	SNI 30 E	340	370	21	20
72477	SN 25 E	350	377	16	15
21822	SNI 30 E	350	380	21	20
126213	SN 25 E	350	380	23	22
151774	SN 25 E	350	390	36	35
69775	SNI 30 E	360	390	21	20
14636	SN 25 E	360	390	23	22
152626	SNI 39 E ZL	360	400	24	23
116179	SN 25 E	370	400	21	20
65048	SN 25 E	370	400	23	22
73366	SN 25 E	370	400	27	26
130251	SN 25 E	380	410	23	22
130252	SN 25 E	390	420	23	22
151869	SNI 30 E	400	415	19.3	18
81155	SN 25 E	400	425	23	22
6205	SN 25 E	400	430	21	20
130254	SN 25 E	400	430	23	22

SN 25/SNI 30/SNI 39

Item No. Code d D L H

Sizes

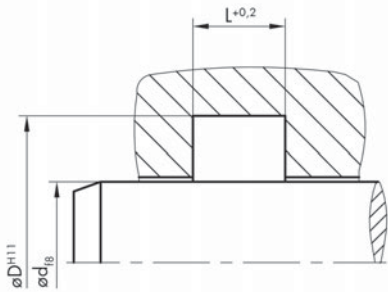

129759	SN 25 E	400	430	26	25
162473	SN 25 E	400	450	42	40
81903	SN 25 E	401	445	29	28
81263	SN 25 E	410	450	21	20
143580	SN 25 E	420	450	21	20
130255	SN 25 E	420	450	23	22
88186	SN 25 E	425	457	25	24
74124	SN 25 E	430	470	29	28
151327	SN 25 E	450	480	21	20
77501	SN 25 E	450	490	35	34
143334	SN 25 E	450	500	26	25
162474	SN 25 E	470	500	26	25
89151	SN 25 E	470	510	29	28
89152	SN 25 E	490	530	29	28
115461	SN 25 E	500	520	11	10
82232	SN 25 E	500	525	23	22
77580	SN 25 E	500	530	19	18
59486	SN 25 E	500	540	35	34
74298	SN 25 E	500	550	40	38
149564	SN 25 E	520	550	26	25
78599	SN 25 E	530	565	26	25
143331	SN 25 E	540	570	16	15
85882	SN 25 E	540	580	17	16
78361	SN 25 E	545	578	17.5	16.5
84948	SN 25 E	550	570	16	15
49577	SNI 30 E	550	580	23.81	22.7
127134	SN 25 E	550	590	29	28
150997	SN 25 E	550	590	36	35
122021	SNI 30 E	560	600	26	25
115757	SN 25 E	610	650	23	22
82948	SN 25 E	620	650	26	25
143332	SN 25 E	660	700	21	20
74450	SN 25 E	700	740	29	28
7502	SN 25 E	700	750	33	32
127429	SN 25 E	709.61	755.65	30.56	28.57
143333	SN 25 E	720	760	21	20
80586	SN 25 E	750	800	31	30
77281	SN 25 E	965.2	1016	20.65	19.05